



VOX
ELECTRONICS

ENG

OWNER'S MANUAL UHD 50ADS314B

KEEP THIS MANUAL FOR FUTURE REFERENCE.

Important Safety Instructions and Maintenance

Important Safety Instructions

CAUTION

Risk of electronic shock, do not open.
Do not attempt to service this product yourself as opening or removing covers may expose you to dangerous voltage or other hazards.
Refer all servicing to qualified service personnel.

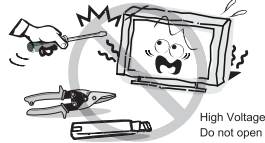

If the following problems occur:
Turn off the TV set and unplug the AC power cord immediately if any of the following problems occur.
Ask your dealer or service centre to have it checked by qualified service personnel

When:

- AC power cord is damaged.
- Poor fitting of AC power outlet.
- TV set is damaged by being dropped, hit or having something thrown at it.
- Any liquid or solid object falls through openings in the cabinet.

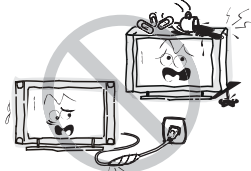

To reduce the risk of fire or electric shock, do not expose this product to rain or moisture.
The apparatus shall not be exposed to dripping or splashing and no objects filled with liquids, such as vases, shall be placed on the apparatus.



The screen and cabinet get warm when the TV is in use. This is not a malfunction. In case of smoke, strange noise or strange smell from the unit:

- Turn off the power switch immediately;
- Disconnect the power plug from the power outlet;
- Contact your dealer or service centre. Never attempt to make repairs yourself because this could be dangerous.



Never push objects of any kind into the set through the cabinet slots as they may touch dangerous voltage points or short-circuit parts that could result in a fire or electric shock. Never spill liquid of any kind on the set. Use special caution in households where children are present. The apparatus is not suitable for children under 3-year to operate.



Do not overload wall outlets, extension cords or adaptors beyond their capacity, this can result in fire or electrical shock.

Power-supply cords should be routed so that they are not likely to be walked on or pinched by items placed upon or against them, paying particular attention to cords at plug end, adaptors and the point where they exit from the appliance. The mains plug is used as the disconnect device. It shall remain readily accessible and should not be obstructed during intended use. Make sure to plug the power cord in until it is firmly inserted. When removing the power cord, make sure to hold the power plug when pulling the plug from the outlet, do not pull the plug out by the wire. NEVER touch the plug or power cord with wet hands. To disconnect the apparatus from the mains power, the plug must be pulled out from the mains socket, therefore make sure the mains plug is always easily accessible.

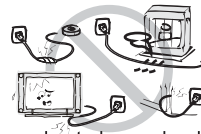

Important Safety Instructions and Maintenance

Important Safety Instructions

Do not push or scratch the front filter, or place any objects on top of the TV set. The image may be uneven or the screen may be damaged.



To avoid the fire, no naked flame source, such as lighted candles, should be placed on the apparatus.

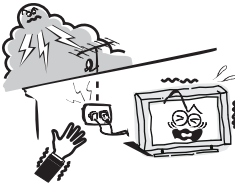

An outside antenna system should not be located in the vicinity of overhead power lines or other electric light or power circuits, or where it can fall into such power lines or circuits. When installing an outside antenna system, extreme care should be taken to keep from touching such power lines or circuits as contact with them might be fatal. Ensuring the television is not overhanging the edge of the supporting furniture.

When not in use

If you will not be using the TV set for several days, the TV set should be disconnected from the AC mains for environmental and safety reasons. As the TV set is not disconnected from the AC power when the TV is turned off at the standby switch, pull the plug from the AC power outlet to disconnect the TV completely. However, some TV sets may have features that require the TV set to be left in standby to function correctly. In the case of lightning, unplug the TV set from the outlet immediately. Never touch the antenna wire during lightning.



Do not pull the plug out by the wire;
Never touch the plug with wet hands.



Excessive volume from earphones and headphones can cause hearing loss.

Installation



The ventilation should not be impeded by covering the ventilation opening with items, such as newspapers, tablecloths, curtains, etc.

At least 10 cm space should be left around the apparatus for sufficient ventilation.



The product should be situated away from heat sources such as radiators, heat registers, stoves, or other products (including amplifiers) that produce heat. Place the apparatus in such a position that the screen is not exposed to direct sunlight. It is best to have soft indirect lighting while watching and avoid completely dark environments and reflection from the screen as these may cause eye fatigue.

Keep the TV set away from any equipment emitting electromagnetic radiation.

Important Safety Instructions and Maintenance

Installation



Do not place the set on an unstable cart, stand, table or shelf. The set may fall, causing serious personal injury as well as damage to the product. Use only with the cart, stand, tripod, bracket, or table specified by the manufacturer, or sold with the apparatus. An appliance and cart combination should be moved with care. Quick stops, excessive force, and uneven surfaces may cause the appliance and cart combination to overturn.



Do not place this apparatus near water, for example, near a bath tub, wash bowl, kitchen sink, or laundry tub; in a wet basement; or a swimming pool; and the like;

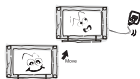

When the TV being moved in from cold place, it needs some right time for dew inside unit evaporating fully before turn on the unit;

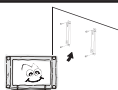

To prevent injury, this apparatus must be securely attached to the floor/wall in accordance with the installation instructions.

LED Screen

Although the LED screen is made with high precision technology and 99.99% or more of the pixels are effective, black dots may appear or bright points of light (red, blue or green) may appear constantly on the LED screen. This is a structural property of the LED screen and is not a malfunction.

If the surface of the LED panel cracks, do not touch it until you have unplugged the AC power cord. Otherwise electric shock may result.

Do not throw anything at the TV set. The LED panel may break from the impact and cause serious injury.

Precautions When Displaying a Still Image

A still image may cause permanent damage to the TV screen.

Do not display still images and partially still images on the LED panel for more than 2 hours as it can cause screen image retention. This image retention is also known as "screen burn". To avoid such image retention, reduce the degree of brightness and contrast of the screen when displaying a still image. Watching the LED TV in 4:3 format for a long period of time may leave traces of borders displayed on the left, right and centre of the screen caused by the difference of light emission on the screen. Playing a DVD or a game console may cause a similar effect to the screen. Damages caused by the above effect are not covered by the Warranty.

Displaying still images from Video games and PC for longer than a certain period of time may produce partial after-images. To prevent this effect, reduce the 'brightness' and 'contrast' when displaying still images.

Cleaning



Cleaning and handling the screen surface and cabinet. Disconnect the unit from the AC outlet before cleaning. To remove dust, wipe gently with a soft, lint free cloth. If required use a slightly damp cloth.



MAINSPLUG

Wipe the mains plug with a dry cloth at regular intervals. Moisture and dust may lead to fire or electrical shock.



Use care not to subject the TV's surfaces to detergent. (A liquid inside the TV could lead to product failure, fire or electrical shock.)

Use care not to subject surfaces to bug repellent, solvent, thinner, or other volatile substances as this may deteriorate the surface and finish of the cabinet.

Important Information

If a television is not positioned in a sufficiently stable location, it can be potentially hazardous due to falling. Many injuries, particularly to children, can be avoided by taking simple precautions such as:

- Using cabinets or stands recommended by the manufacturer of the television.
- Only using furniture that can safely support the television.
- Ensuring the television is not overhanging the edge of the supporting furniture.
- Not placing the television on tall furniture (for example, cupboards or bookcases) without anchoring both the furniture and the television to a suitable support.
- Not standing the televisions on cloth or other materials placed between the television and supporting furniture.
- Educating children about the dangers of climbing on furniture to reach the television or its controls.
- Keep small accessories out of reach of children so they are not mistakenly swallowed.

Table of Contents

Accessories	5
Introduction	6
Features.....	6
Specifications.....	7
Stand and wall-mounting instructions (optional)	8
General Description	10
Overview of back panel.....	10
Overview of front panel.....	11
Overview of remote control.....	12
Installing Batteries in the Remote Control.....	14
External Connection	14
Antenna connection.....	14
Connecting VCR.....	15
Connecting a Camcorder.....	16
Connecting DVD Player/Set-Top Box via HDMI.....	17
Connecting Digital Audio System.....	18
Connecting PC.....	19
Supporting signals	19
Basic operation	20
Turning the TV on and off.....	20
Setup Wizard.....	21
Menu system instruction	25
Setting.....	25
Image.....	26
Sound.....	27
Channel.....	29
Program.....	32
Function.....	34
Time.....	38
PVR.....	40
DTV.....	42
Troubleshooting	43

Accessories

Please make sure the following items are included with your LED TV. If any items are missing, contact your dealer.



Remote Control

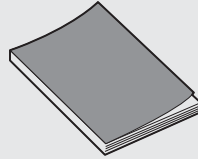

Owner's
Instructions

Introduction

Features

- TV adopts 50" TFT LED display screen
- Zero X radiation complies to green environment protection requirement
- Connect to computer directly to realize TV/monitor combo.
- Android 6.0
- USB 2.0
- 16:9 wide screen
- Auto tuning and fine tuning
- HDMI input (HDMI1 also supports ARC)
- Component Compatible (480i; 480P; 576i; 576P; 720P; 1080i; 1080P;2160i; 2160P)
- PC VGA
- Programmable sleep timer
- Wide range voltage input
- No-signal automatic power off

Input terminals used for external equipment connection

- 1 x RF in
- 1 x DVB-S2
- 1 x AV input
- 1 x Computer PC-RGB input
- 1 x COMPONENT input
- 1 x Optical output
- 1 x RJ-45 NET Input
- 1 x TF card input
- 1 x Headphone output
- 2 x USB inputs
- 3 x HDMI inputs
- 1 x CI card input

Introduction

Specifications

Model	UHD 50ADS314B	
Display size	50" Diagonal (max.)	
LED panel resolution	3840x2160	
Speaker output power	≤ 10WX2	
Power supply	100-240V~, 50/60Hz	
TV receive system	Digital: DVB-T/T2, DVB-C, DVB-S/S2 Analog: PAL: BG, I, DK, SECAM: BG, D/K	
Frequency range	Analog: Antenna: 46.25MHz-855.25MHz Digital : DVB-T/T2: 5-12,21-69 DVB-C: 113MHz~898MHz DVB-S/S2: 950MHz-2150MHz	
Video in	PAL/NTSC	
Power consumption	138W	
Standby consumption	≤ 0.5W	
Antenna input	75 ohms, unbalanced	
Controller power	DC 3V (Two AAA size batteries)	
Dimensions (LxWxH)	TV with stand	1126.6x270.3x708.8mm
	TV without stand	1126.6x81.2x653.1mm
Weight (Net weight)	TV with stand	10.23Kg
	TV without stand	10.09Kg
Work temperature	0°C-40°C	

NOTES:

- Design and specifications are subject to change without notice.
- Weight and Dimension shown are approximate.

Stand and wall-mounting instructions (optional)

How to assemble the stand

If you need to remove or assemble the stand please read the following instructions.

- Before attaching/detaching the stand, make sure to turn off the TV.
- Before performing work, spread cushioning over the base area to lay the LED TV on. This will prevent it from being damaged.

Assembling instruction:

Put the television on the table, fix the stands with four screws given in the carton.

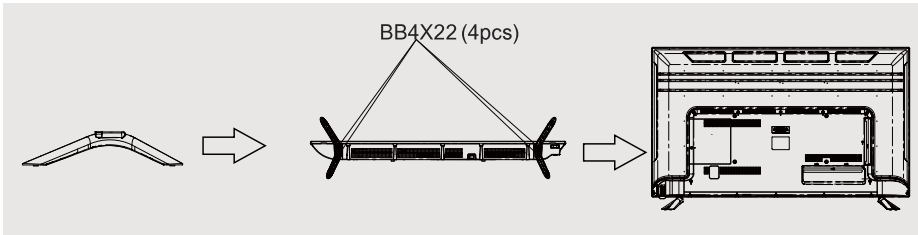

Stand and wall-mounting instructions (optional)

Wall mounting instructions(optional):

Your LED TV is able to accommodate wall mounting with the use of a wall mount bracket (not supplied with LED TV, please contact your local hardware store) and the mounting holes on the back of the unit. We recommend removing the TV stand prior to wall mounting the TV. Please see previous page for instructions on removing the stand.

Mounting instruction:

1. Fasten mounting screws and sleeves together into the 4 screw holes on the rear cover
2. Fasten wall mounting bracket with screws on the wall
3. Left the TV and hang it on the wall

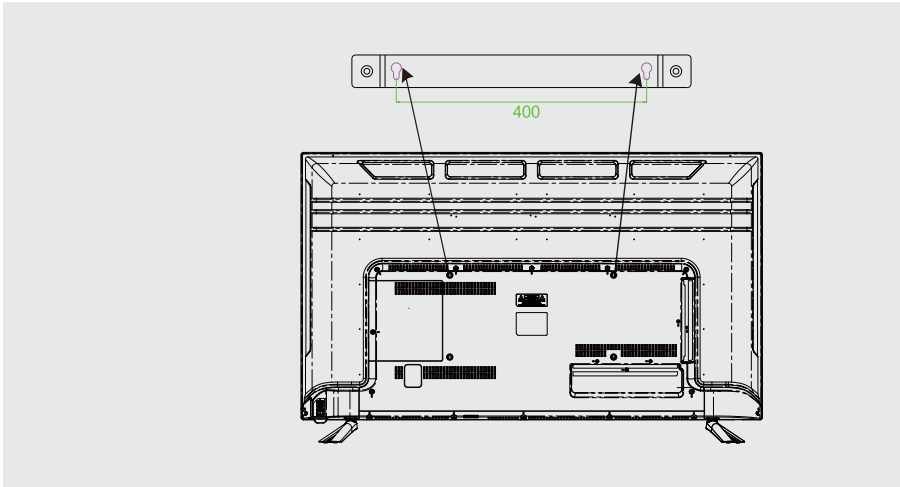

General Description

Overview of back panel

You can connect the TV with video devices such as DVD/VCD player, VCR and video camera to enjoy the high quality picture.

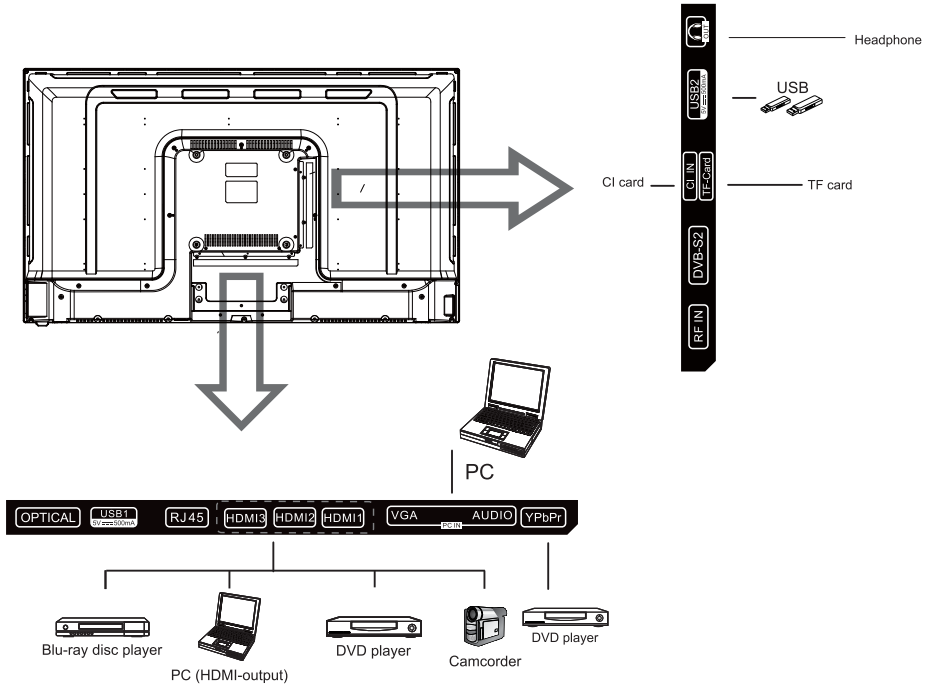

General Description

Overview of front panel

The buttons on the lower-left panel control your TV's basic features, including the on-screen menu. To use the more advanced features, you must use the remote control.

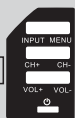
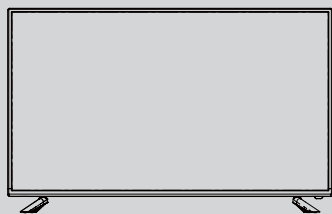

- ①  Turn on/off TV.
- ② VOL- } VOL+/-:Adjust Volume.
- ③ VOL+ }
- ④ CH- } CH+/-:Select channel.
- ⑤ CH+ }
- ⑥ **MENU** Into or exit from menu (Use CH+/- button select item, VOL +/- button adjust item) .
- ⑦ **INPUT** Source Select.

General Description

Overview of Remote Control

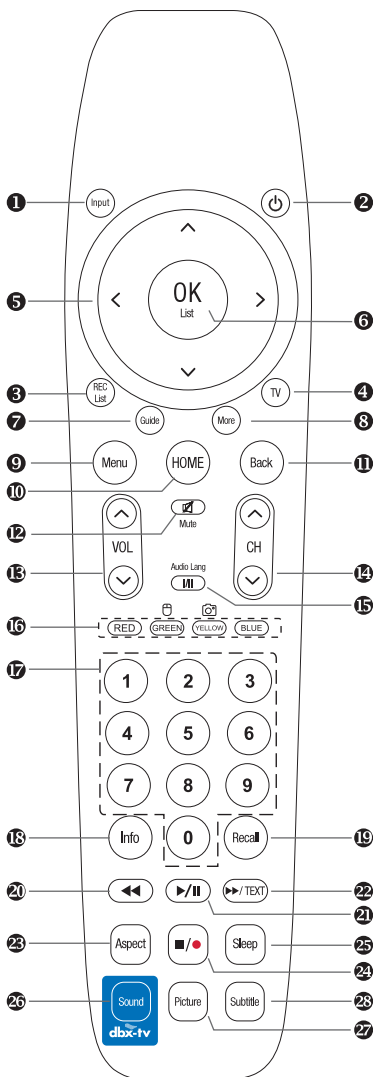

1. **INPUT:** This button is used to switch among different sources: DTV, ATV, AV, YPbPr, VGA, HDMI1, HDMI2, HDMI3. Select a source and press OK button to confirm.
2. **POWER:** Press this button to switch to standby mode, and press it again to turn TV on.
3. **REC LIST:** Press this button to display a list of recorded programs in DTV.
4. **TV:** Press this button to enter TV source.
5. **Arrow buttons:** Press these buttons to move cursor up / down / left / right for menu.
6. **OK LIST:** Press this button to display a channel list, or confirm your selection.
7. **GUIDE:** In DTV source, this button is used to start the EPG application.
8. **MORE:** Press this button to display "MORE" menu. You can use virtual buttons in "more" menu to control TV functions as remote.
9. **MENU:** Press this button to display quick menu or exit the menu.
10. **HOME:** Press this button to enter the main interface directly.
11. **BACK:** Return to previous page.
12. **MUTE:** Press this button to shut off sound of the TV, press again to restore TV sound.
13. **VOL+ and VOL-:** Press these buttons to adjust TV volume.
14. **CH Δ and CH ∇ :** Press these buttons to change channel upward or downward. In the teletext, these buttons are used to display the next page and previous page.
15. **I/II button/AUDIO LANG:** In ATV source, the button is used to set NICAM sound system. In DTV source, the button is used to set the audio language.
16. **Red/Green/Yellow/Blue Command:** These four buttons are used to request linked buttons with the current menu/page. Press the Green button can make the TV RC(TV remote controller) as mouse, and long press the YELLOW button can capture screen image. Press Red button can switch AD(Audio Discription) Function On/Off.

General Description

Overview of Remote Control

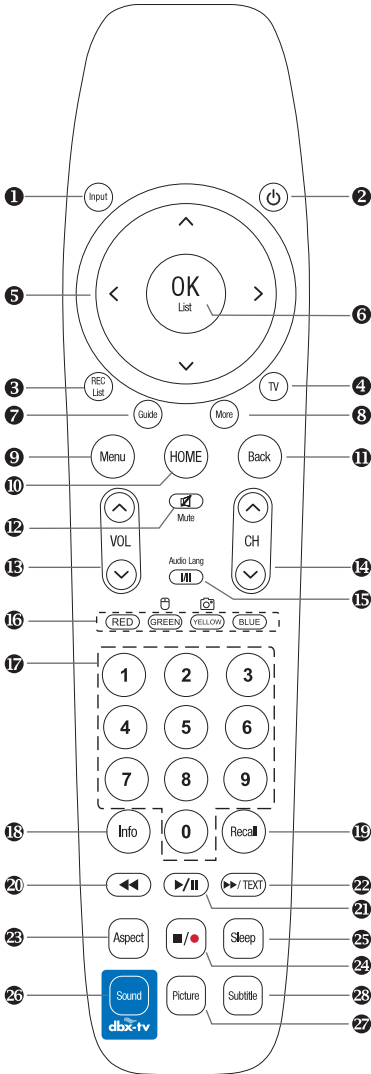

17. **Digital buttons(0~9)**: To select channel with digital buttons.
18. **INFO**: This button is used to display source information or current program information.
19. **RECALL**: Switch to the previous program.
20. **◀◀**: Use as backward function in USB Video/Audio playing Mode. Use as reveal function in ATV Text Mode.
21. **▶/II**: Use as Play/Pause function in USB Video/Audio playing Mode. Use as TimeShift function in DTV.
22. **▶▶/TEXT**: Use as forward function in USB Video /Audio playing Mode. In ATV Mode, press this button to Enter Text Mode. Use as cancel function in ATV Text Mode.
23. **ASPECT**: Press this button to switch the screen mode.
24. **■/●**: Use as Stop function in USB Video/Audio playing Mode. Use as Recording function in DTV.
25. **SLEEP**: TV will be switched off automatically at preset sleep time if you have set sleep timer. Use your remote control to set the sleep timer. Press SLEEP button on the remote control, then press this button again to set sleep time: off, 10, 20, 30, 60, 90, 120, 180, 240 min.
Notes: The sleep timer you have set will be cancelled when the TV turns off or if a power failure occurs.
26. **SOUND**: This button is used to select the sound mode.
27. **PICTURE**: This button is used to adjust the picture mode.
28. **SUBTITLE**: Turning the subtitles on or off in DTV or ATV Teletext mode.

General Description

Installing Batteries in the Remote Control

Installing Batteries

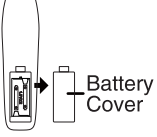
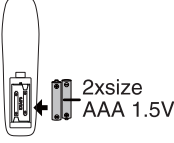
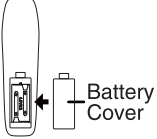
- 1** Open the battery compartment cover on the back side.

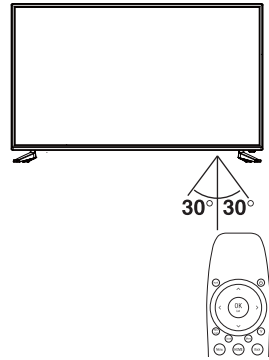
- 2** Insert two 1.5V AAA size batteries in correct polarity. Don't mix old or used batteries with new ones.

- 3** Closed the cover.



- ✦ Point the remote towards the remote control sensor of the TV and use it within 8 meters.
- ✦ Put the used batteries into the recycling bin since they can negatively affect the environment.

NOTES:

- One loading of batteries will last for 1 year under normal use.
- If you do not intend to use the remote controller for a long period of time, remove them to avoid damage due to leakage.
- Do not use old and new batteries together.
- The batteries (battery pack or batteries installed) shall not exposed to excessive heat such as sunshine, fire or the like.

External Connection

Antenna connection

Antenna input impedance of this unit is 75ohm. VHF/UHF 75ohm coaxial cable can be connected to the antenna jack directly, if the antenna cable is 300ohm parallel flat feeder cable, you need to use the 300ohm/75ohm converter to connect the antenna cable to the antenna jack. For details Please refer to the following drawing.

Antennas with 300 Ω flat twins Leads

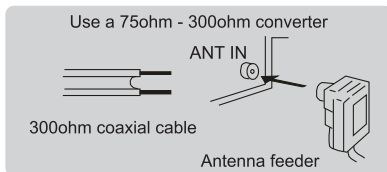

Antennas with 75 Ω Round Leads

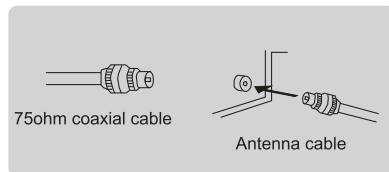

External Connection

Connecting VCR

These instructions assume that you have already connected your TV to an antenna or a cable TV system. Skip step 1 if you have not yet connected to an antenna or a cable system.

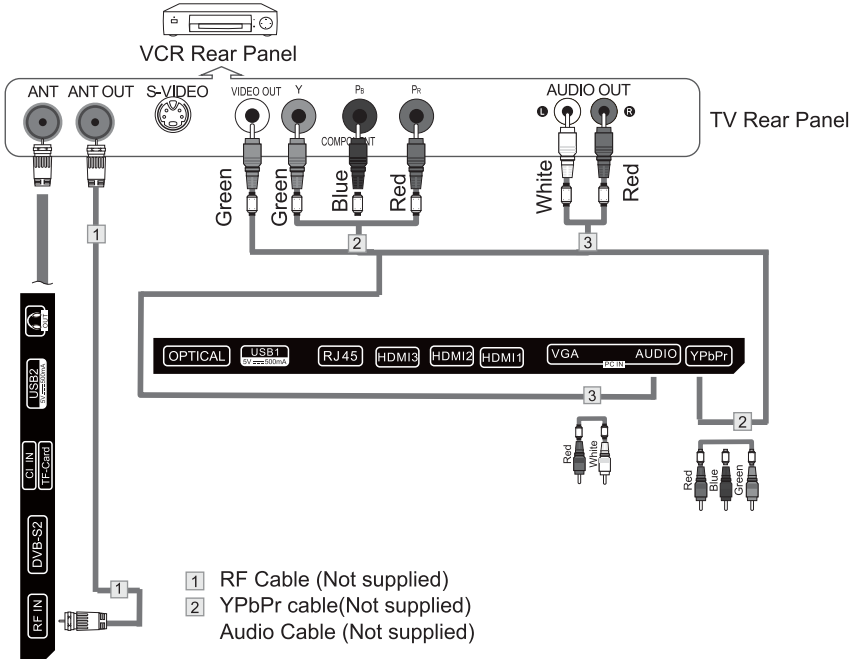

Follow the instructions in Viewing a VCR or Camcorder Tape to view your VCR tape.

Each VCR has a different back panel configuration.

When connecting a VCR, match the color of the connection terminal to the cable.

1. Unplug the cable or antenna from the back of the TV.
2. Connect the cable or antenna to the ANT IN terminal on the back of the VCR.
3. Connect an RF Cable between the ANT OUT terminal on the VCR and the ANT IN terminal on the TV.
4. Connect a Component Cable between the COMPONENT [Y, Pb, Pr] jacks on the DVD player and YPbPr jack on the TV.
5. Connect Audio Cables between the AUDIO OUT jacks on the VCR and the AUDIO L and AUDIO R jacks on the TV.

Note:

1. Whenever you connect an external device to your TV, make sure that power on the unit is turned off.
2. When connecting an external device, match the color of the connection terminal to the cable.

External Connection

Connecting a Camcorder

The rear panel jacks on your TV make it easy to connect a camcorder to your TV. They allow you to view the camcorder tapes without using a VCR.

Each Camcorder has a different back panel configuration.

When connecting a Camcorder or DVD, match the color of the connection terminal to the cable.

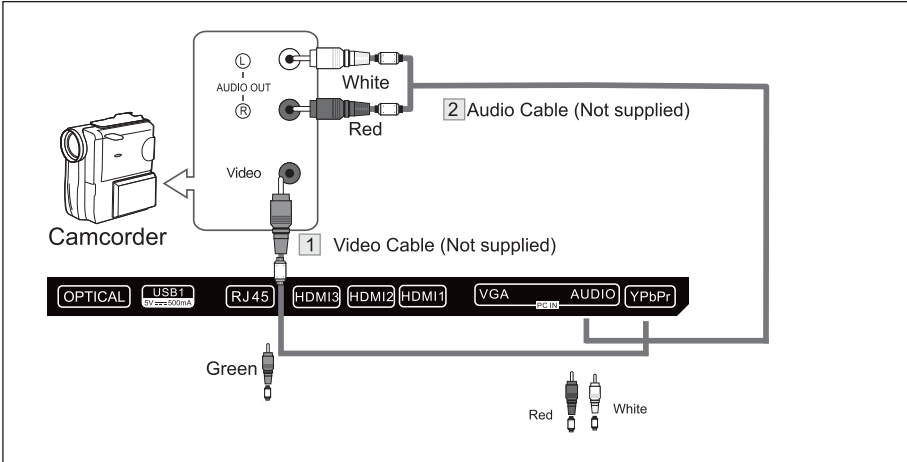

1. Connect a Video Cable between the AV VIDEO in jacks on the TV and the VIDEO OUT jack on the camcorder.
2. Connect Audio Cables between the AUDIO L and AUDIO R jacks on the TV and the AUDIO OUT jacks on the camcorder.
3. Connect a Video Cable between the AV VIDEO IN jacks on the TV and the VIDEO OUT jack on the DVD.
4. Connect Audio Cables between the component IN AUDIO L and R jacks on the TV and the AUDIO OUT jack on the DVD.

Notes:

1. Whenever you connect an external device to your TV, make sure that power on the unit is turned off.
2. When connecting an external device, match the color of the connection terminal to the cable.

External Connection

Connecting DVD Player/Set-Top Box via HDMI

This connection can only be made if there is a HDMI Output connector on the external device.

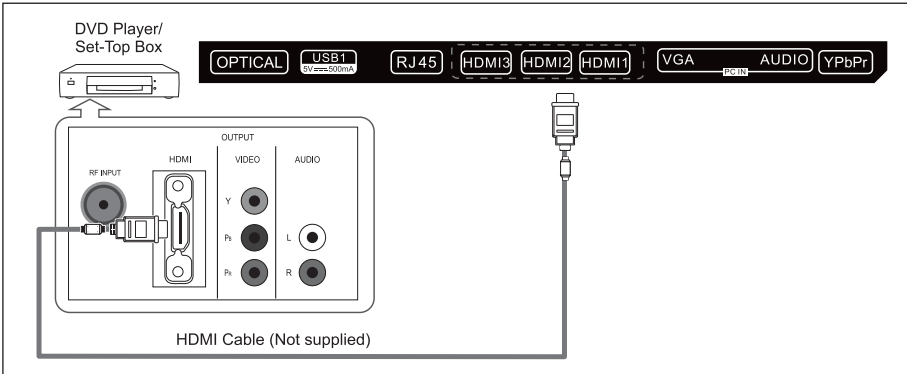

What is HDMI?

HDMI, or high-definition multimedia interface, is a next-generation interface that enables the transmission of digital audio and video signals using a single cable without compression. Multimedia interface is a more accurate name for it especially because it allows multiple channels of digital audio (5.1 channels).

The difference between HDMI and DVI is that the HDMI device is smaller in size, has the HDCP (High Bandwidth Digital Copy Protection) coding feature installed, and supports multi-channel digital audio.

Each DVD player/STB has a different back panel configuration.

Connect an HDMI Cable between the HDMI1, HDMI2, HDMI3 connector on the TV and the HDMI connector on the DVD player/Set-Top Box.

Notes:

- 1. Whenever you connect an external device to your TV, make sure that power on the unit is turned off.**
- 2. When connecting an external device, match the color of the connection terminal to the cable.**

External Connection

Connecting Digital Audio System

The rear panel jacks on your TV make it easy to connect a Digital Audio System to your TV.

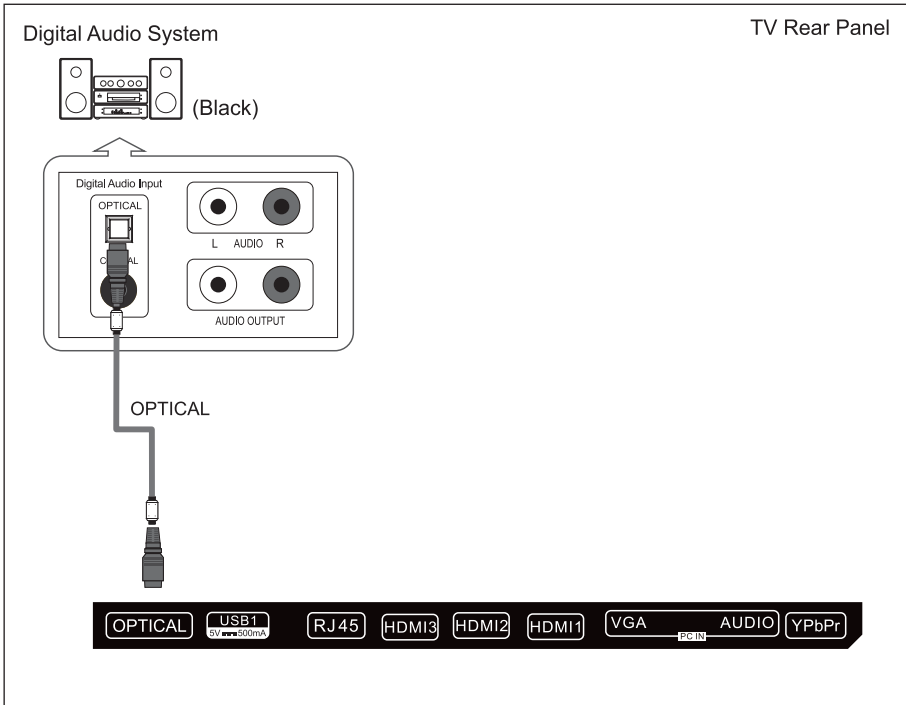

5.1 CH audio is possible when the TV is connected to an external device supporting 5.1 CH.

Connect an SPDIF Cable between the SPDIF jacks on the TV and the Digital Audio Input jacks on the Digital Audio System. When a Digital Audio System is connected to the SPDIF terminal: Decrease the gain (volume) of the TV, and adjust the volume level with the Digital Audio System's volume control.

External Connection

Connecting PC

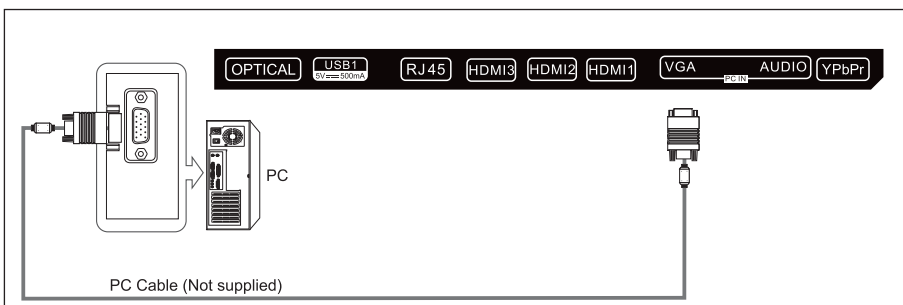

Each PC has a different back panel configuration. Connect a PC Audio Cable between PC AUDIO IN jack on the TV and the Audio Out jack of the soundcard on your computer.

You should set PC software before you connect a PC to your TV (please refer to "PC Display" settings)

Notes:

1. Whenever you connect an external device to your TV, make sure that power on the unit is turned off.
2. When connecting an external device, match the color of the connection terminal to the cable.

Supporting Signals

Input	Mode
DTV	Digital: DVB-T/T2, DVB-C, DVB-S/S2
ATV	PAL BG I DK
	SECAM BG DK
CVBS	PAL/NTSC/SECAM

Input	Resolution	Vertical Frequency	
PC/VGA	VGA	640x480	60Hz
	SVGA	800X600	60Hz
	XGA	1024X768	60Hz
	SXGA	1280X1024	60Hz
		1360X768	60Hz
		1920X1080	60Hz

Input	Resolution	Vertical Frequency
Component	480i	60Hz
	480p	60Hz
	576i	50Hz
	576p	50Hz
	720p	50Hz/60Hz
	1080i	50Hz/60Hz
	1080p	50Hz/60Hz
HDMI	480p	60Hz
	576p	50Hz
	720p	50Hz/60Hz
	1080i	50Hz/60Hz
	1080p	50Hz/60Hz
	3840x2160	24Hz/25Hz/30Hz/60Hz

Supporting Signals

This TV is embedded with one digital media player. It can find devices that support USB1.1/2.0, including flash disk, USB hard disk and digital camera. It supports functions as: Display picture, Play music files, Play video files.

Note: Please do not remove the cable during the data transfer. It may cause problems for the system.

Picture	Codec	JPEG, PNG, BMP
Music	Audio Codec	MP-(1/2/3), AAC, AC3
Video	Container	MPG, MPEG, MP4, MKV, 3GPP, AVI, FLV
	Video Codec	HD/FHD: MPEG-(1/2/4), MVC, H.264, H.265 UHD: H.264, H.265
	Audio Codec	MP-(1/2/3), AAC, AC3

Basic Operation

Turning the TV On and Off

How to turn the TV on or off

1. Insert the power cord plug into a polarized AC outlet.
2. If TV is in standby mode, press **POWER** button on the remote control or \odot button on the bottom panel of LED TV.
3. Normal picture will be displayed on the screen after 15 seconds. If no signal input, "No Signal" will be displayed on the screen.
4. If temporary POWER off is required, press **POWER** button on the remote control or \odot button on the bottom panel.
5. If you want to completely switch off the power for this unit, unplug the power cord plug for this unit.
6. After switching off the unit, you should wait at least 5 seconds before switching on again.

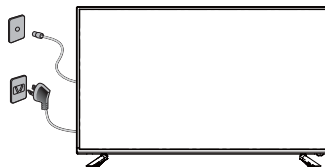

Status indication lamp

Light on: In standby mode.

Light off: In power on mode.

Auto power-off

1. If there is no signal, the TV will automatically enter standby mode after 10 minutes.
2. In VGA mode, if no any operation 15 seconds later, TV will enter standby mode.

Memory before turning TV off

The picture and sound settings and preset channels will be memorized at the point when the TV is turned off. When the TV is started up again it will work accordingly with these settings.

Basic Operation

Setup Wizard

When first boot the TV, you will enter the TV guide system.

OSD Language Setting



1. Press ▲/▼ key to select the language.
2. Press ► key then press "START" button to enter the home page.

Country Setting

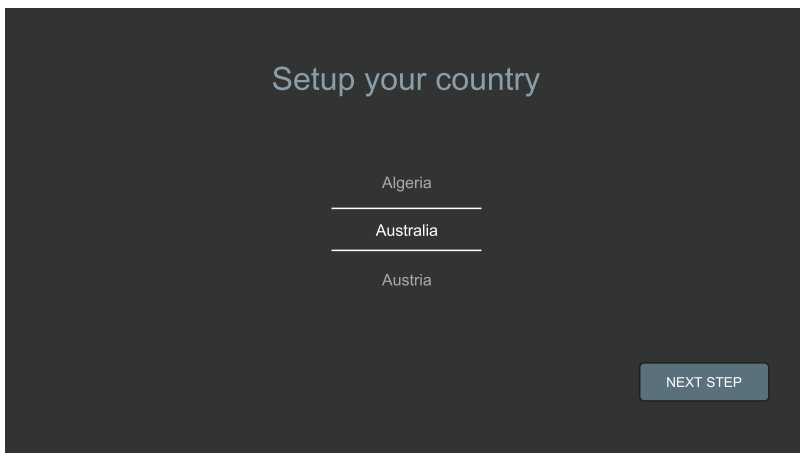

1. Press ▲/▼ key to select the type of your country (Algeria/Australia/Austria).
2. Press ► key then press "NEXT STEP" button to enter the next step.

Basic Operation

Setup Wizard

Network Settings

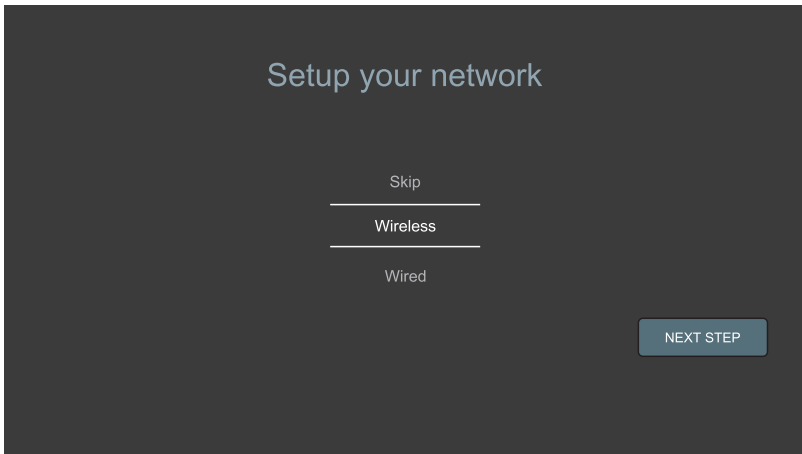

1. Press ▲/▼ key to select the type of your network(Skip/wired/wireless).
2. Press ► key then press "NEXT STEP" button to enter the next step.

Setup Wifi



1. You should wait about 5-8s to display the wifi list.
2. Press ▲/▼ key to select the type of your wifi.

Setup Wired network



1. Press ▲/▼ key to select the type of your set up the way(DHCP/STATIC).
2. Press ► key then press "NEXT STEP" button to enter the next step.

Basic Operation

Setup Wizard

MENU OPERATION

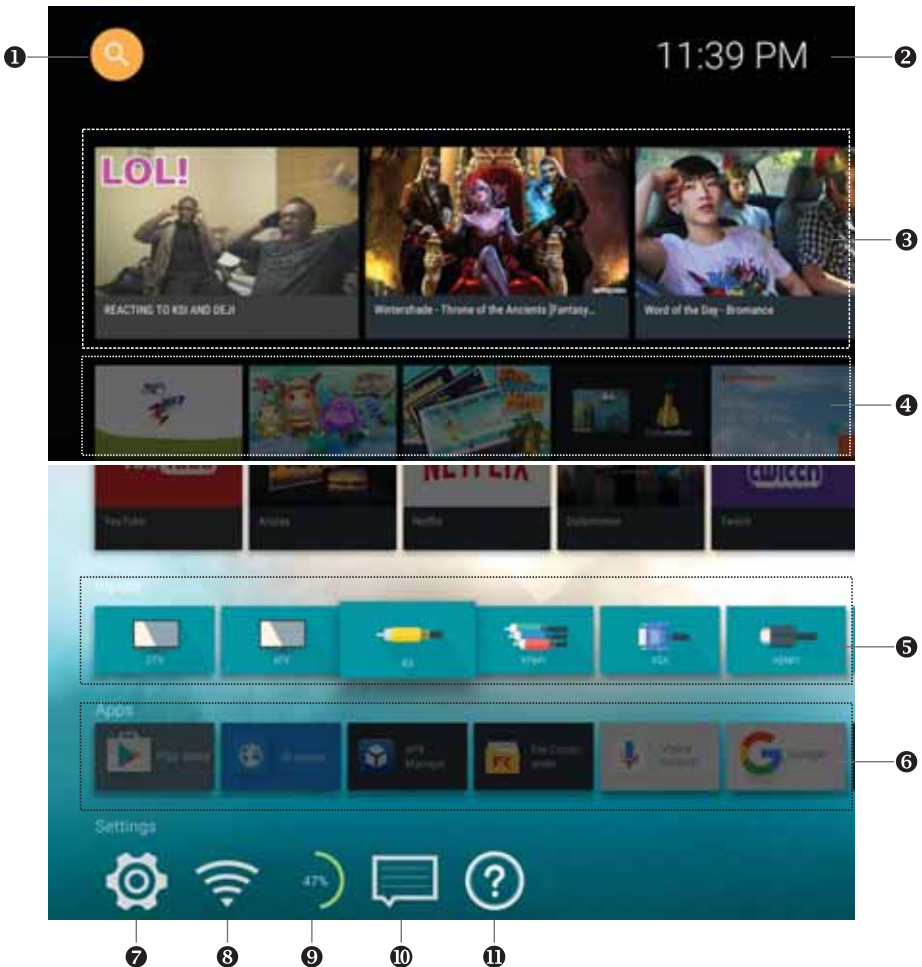

Arrow buttons: Select an item on the menu.

OK button: Enter the options which you've selected.

1. Google Search

2. Current Time

3. What's hot: Hot Video on Internet.

4. Featured app: featured apps on Internet for TV.

5. Inputs: Input sources on TV(DTV, ATV, AV, YPbPr, VGA, HDMI1, HDMI2, HDMI3).

6. Apps: All applications installed on TV.

7. Settings: All Setting Options on TV.

8. Net Status: Display your network status. Enter this option to set your network.

9. RAM: Memory have been used.

10. Message Center.

11. Help.

Basic Operation

Setup Wizard

Quick Menu



In TV source, there is a Quick Menu for some Options you may want to use.

MENU button: Open the Quick menu or Exit the menu.

BACK button: Exit the menu.

Arrow buttons: Select an option which you want.

OK button: Enter the option you have selected.

Menu system instruction

Setting

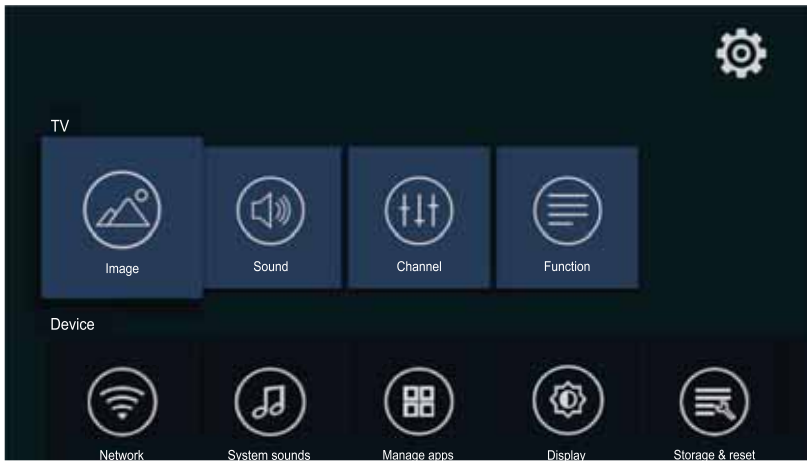

User may explorer all functions there.

Menu system instruction

Setting

Preferences

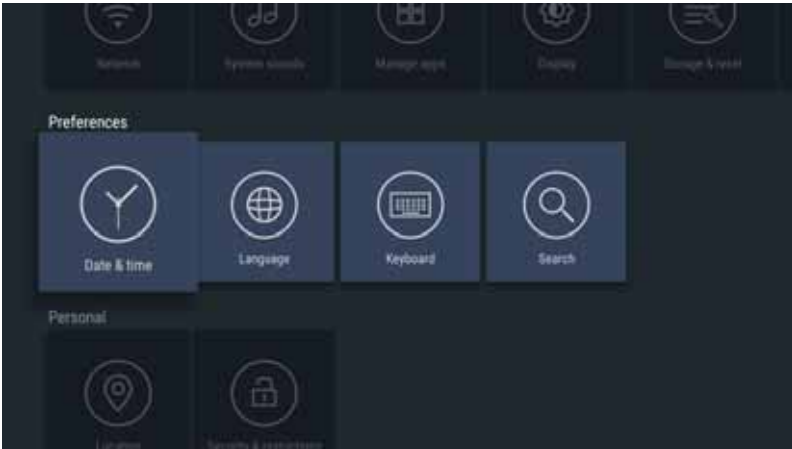

Date & time: You can make the adjustment of the date and time;

Language: You can change the language that you need;

Keyboard: Configure of the keyboard;

Search: Google search;

Image

PICTURE MODE

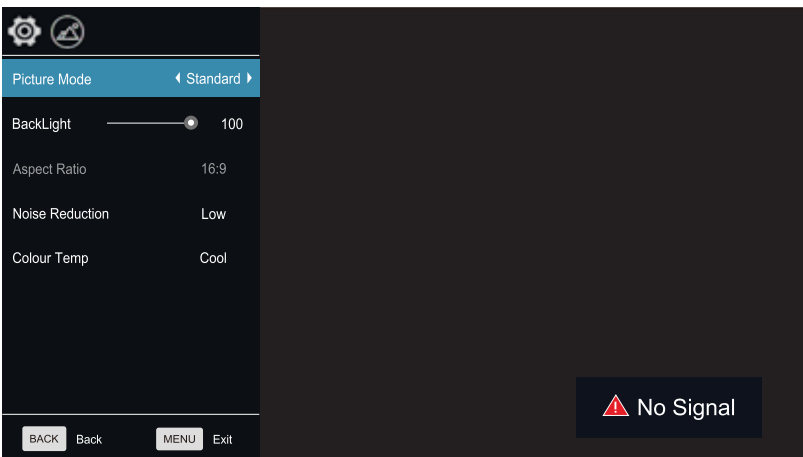

Your TV has these picture settings (Soft, Vivid, User, Dynamic, Standard) that are preset at the factory. Only "User" mode can be set to your preference by adjusting particular items such as Contrast, Brightness, Color, Sharpness, Tint.

1. Press ▲/▼ key to select "Picture Mode" option.
2. Press ◀/▶ key to select one picture mode.

Menu system instruction

Image

Backlight

Adjust Backlight.

1. Press ▲/▼ key to select "Backlight" option.
2. Press ◀/▶ key to adjust Backlight value.

Aspect Ratio

You can select the picture size which best corresponds to your viewing requirement.

1. Press ▲/▼ key to select "Aspect Ratio" option.
2. Press ◀/▶ key to set the scale mode. You can also press "Aspect" key on the remote control to select one of the scale modes. Each source has different scale modes.

Color Temp

You can change the color of the entire screen according to your preference.

1. Press ▲/▼ key to select "Color Temp" option.
2. Press ◀/▶ key to select one color temp.

Standard: Keeps whites white.

Warm: Makes whites reddish.

Cool: Makes whites bluish.

Noise Reduction

1. Press ▲/▼ key to select "Noise Reduction" option.
2. Press ◀/▶ key to adjust noise reduction mode.

Note: Noise Reduction doesn't work in VGA Mode.

Sound

Sound Mode

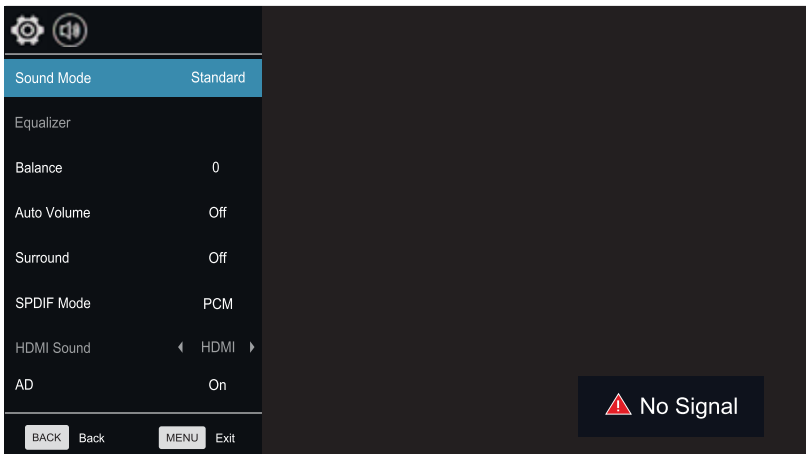

You can select the type of special sound settings to be used when watching a given broadcast. Your TV has five sound settings ("Standard", "Music", "Movie", "Sports", "User")

Standard: Selects the normal sound mode.

Music: Select the sound mode for music.

Movie: Provides live and full sound for movies.

Sports: Emphasizes bass over other sounds.

User: Selects your custom sound settings (See "User settings for Sound").

Menu system instruction

Sound

Equalizer

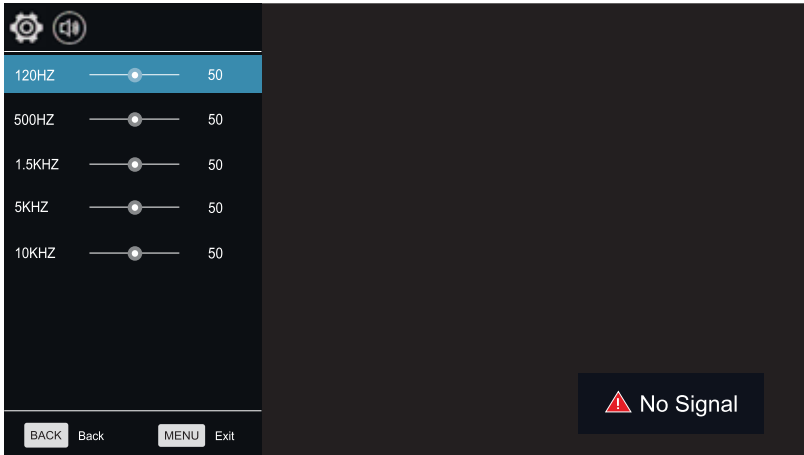

1. Press ▲/▼ key to select an equalizer item.
2. Press OK key to enter the equalizer submenu.
The sound settings can be adjusted to suit your user preferences.
1. Press ▲/▼ key to select a particular item.
2. Press ◀/▶ key to decrease or increase the value of a particular item.

Note: The adjusted values are stored according to the selected particular item.

Balance

If the volumes of the left speaker and the right speaker are not the same, you can adjust the "Balance" to suit your personal preference.

1. Press ▲/▼ key to select "Balance" option.
2. Press ◀/▶ key to decrease or increase the value of the item.

Auto Volume

Each broadcasting station has its own signal conditions, and it is inconvenient to adjust the volume every time the channel is changed. "Auto Volume" automatically adjusts the volume of the desired channel by lowering the sound output when the modulation signal is high or by raising the sound output when the modulation signal is low.

1. Press ▲/▼ key to select "Auto Volume" option.
2. Press ◀/▶ key to select "On" or "Off".

Surround Sound

This is used to turn on surround sound to gain better sound effect.

1. Press ▲/▼ key to select "Surround" option.
2. Press ◀/▶ key to select "On" or "Off".

SPDIF Mode

This is used to select "SPDIF Mode". This option is only used in HDMI/DTV mode.

1. Press ▲/▼ key to select "SPDIF Mode" option.
2. Press ◀/▶ key to select "RAW", "PCM" or "OFF".

Menu system instruction

Sound

HDMI Sound

This option is only used in HDMI mode.

1. Press ▲/▼ key to select "HDMI Sound" option.
2. Press ◀/▶ key to select HDMI Sound mode, HDMI or VGA.

Note: HDMI Sound is just enabled in source HDMI.

AD

This option is only used in DTV mode.

1. Press ▲/▼ key to select "AD" option.
2. Press ◀/▶ key to select "On" or "Off".

AD Volume

1. Press ▲/▼ key to select "AD Volume" option.
2. Press ◀/▶ key to decrease or increase the value of the item.

Channel

Antenna Type

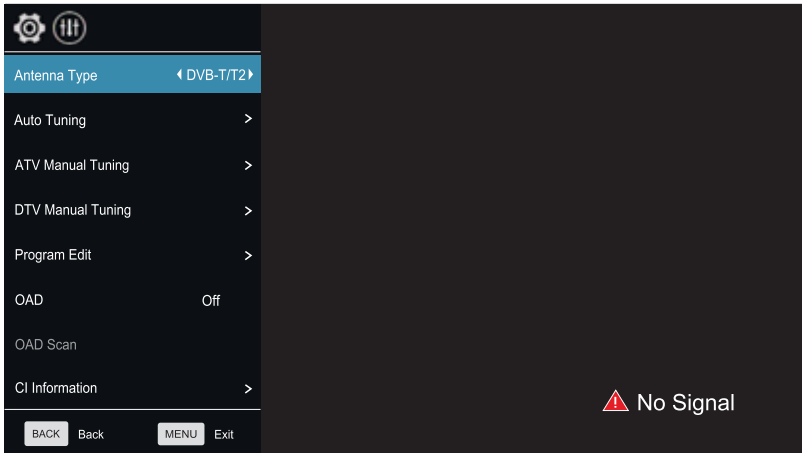

1. Press ▲/▼ key to select "Antenna Type" option.
2. Press ◀/▶ key to select the type of antenna: DVB-C, DVB-T/T2, DVB-S.

Menu system instruction

Channel

Auto Tuning

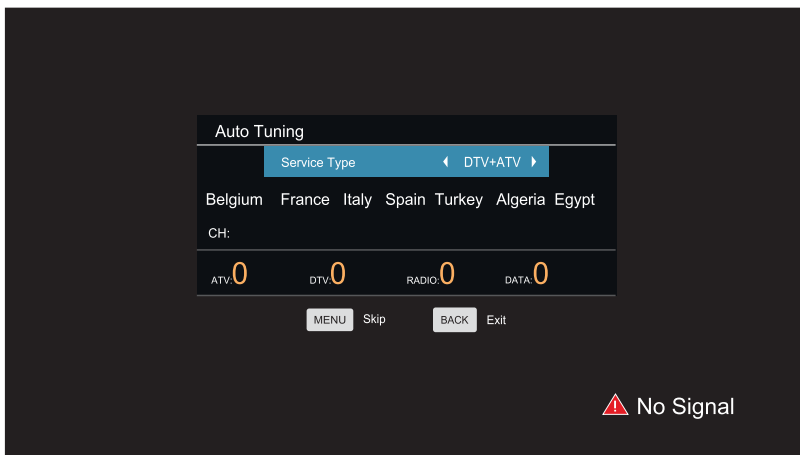

Press ▲/▼ key to select "Auto Tuning" option. You can select country in the list view and set "Search Type" option. The number of searched channels will be shown on the screen.

If you set "Tune Type" to "DTV+ATV", when the searching of DTV channels is over, TV will start to search ATV channels. When the whole searching is finished, all the channels will be stored in memory.

If the Antenna Type is DVB-S, firstly you should set the DVB-S Option. You can set the satellite, scan mode, tune option etc in this menu.

Note: If you want to exit the whole searching, you can press **BACK** button.

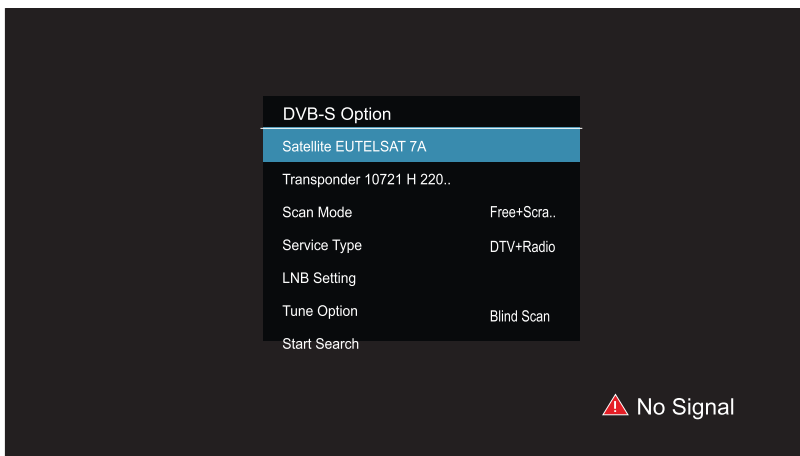

Menu system instruction

Channel

ATV Manual Tuning

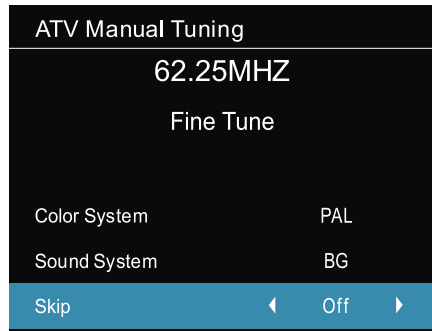
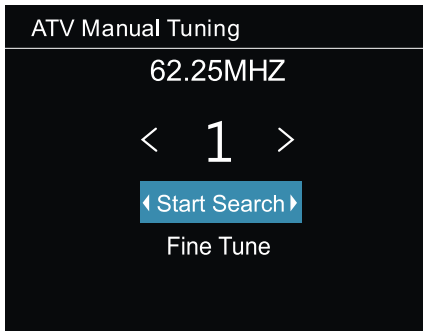

In the ATV/DTV source, you can choose "ATV Manual Tuning" to enter "ATV Manual tuning" menu.

Current CH: You can see the current channel number and you can press ◀/▶ button to choose the channel you want to modify.

Color System: Select the "Color System" option, press ◀/▶ on the remote control or TV. The color system will be changed repeatedly in the order: PAL, SECAM, NTSC, or AUTO.

Sound System: Select the "Sound System" option, press ◀/▶ on the remote control or TV. The sound system will be changed repeatedly in the below order: BG, DK, I, L or M.

Search: You can use ▶ button to search channels from low frequency to high frequency and use ◀ button to search channels from high frequency to low frequency. When you have searched a channel, the searching will be paused and you can press it again for other channels after you store the channel.

Fine Tune: In case of unfavorable image or sound of TV program, you can use "Fine Tune".

Skip: Select "Skip" option, "be changed" on the remote control or TV to switch, select "ON" to skip current program, select "OFF" to add the program into the program list.

Frequency: You can see the frequency of the searched channels.

DTV Manual Tuning

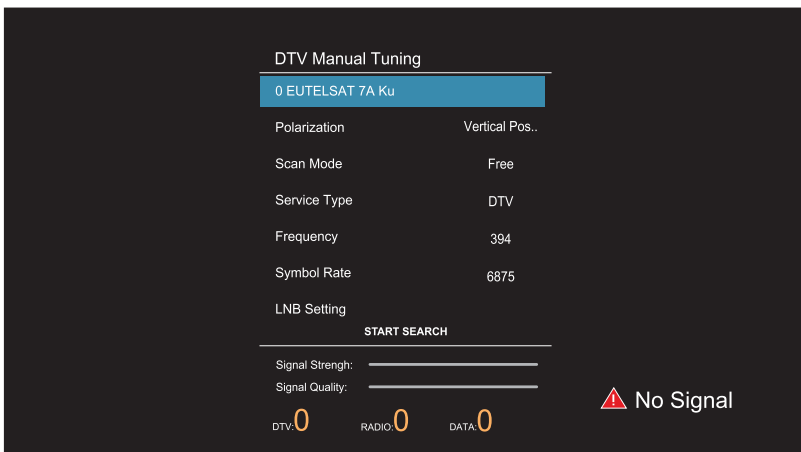

Menu system instruction

Channel

In the ATV/DTV source, you can choose "DTV Manual Tuning" to enter "DTV Manual Tuning" menu.

If the Antenna Type is DVB-C, you can use ◀/▶ button to choose the Frequency. If the Antenna Type is DVB-T, you can use ◀/▶ button or input number to choose the channel. If the Antenna Type is DVB-S, you can select the satellite and other settings. Then press OK button to search, the TV will store the DTV channel if there is a DTV signal present.

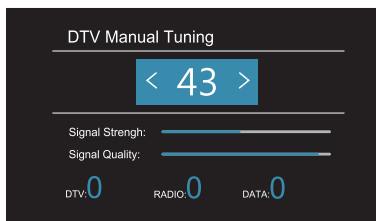

Program

Program Edit

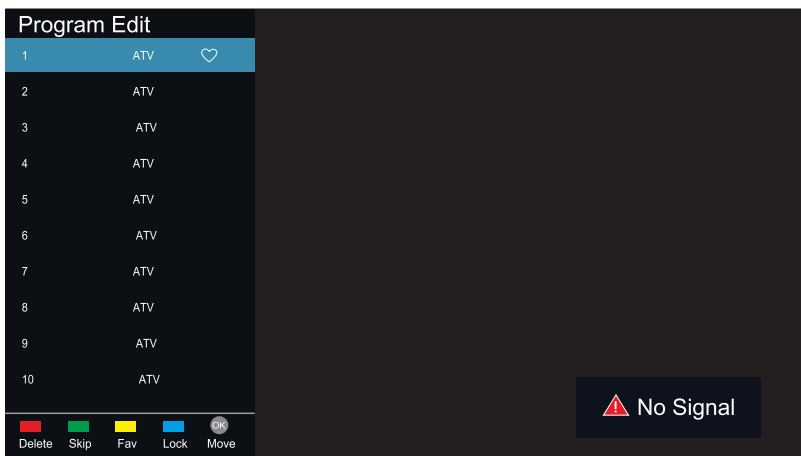

You can use ▲/▼ button to choose "Program Edit" and enter the menu, press the color button on the remote control to skip, delete and lock programs, or add programs to your favorite list.

Delete: You can press RED button to delete the selected channel, then choose the channel you want to delete and press RED button again to delete.

Skip: You can press Green button to skip the channel. The channel will be skip when you change channels. Also, the channel will be skip in channel list.

Fav: You can press "Yellow" button in the menu to add channels to your favorite list. Then you can press ◀/▶ button on the remote control to switch between channel list and favorite list in list menu.

Lock: If you don't want your children or your guest user to watch the channel without your permission, you can press Blue button to lock the channel. Once the channel is locked and Lock System is on, password is needed to enter it.

Move: You can use the OK button to adjust the sequence of the programs.

Menu system instruction

Program

Signal Information (Used only in DTV)



1. Press ▲/▼ key to select "Signal Information" option.
2. Press "OK" or ► key, you can see the information of the DTV channel.

Note:

Signal Quality/Signal Strength (DTV Only):

Unlike analogue channels, which can vary in reception quality, digital channels must have perfect reception quality or you will not receive them at all. So, unlike analogue channels, you are not able fine tune a digital channel. If the signal strength indicates that the signal is weak, a possible solution is to adjust your antenna to increase the signal strength. Continue to adjust the antenna until you find the best position with the strongest signal.

OAD (On Air Download)

This option is used to enable or disable system software update from DTV broadcast.

1. Press ▲/▼ button to select "OAD" option.
2. Press ◀/▶ button to select "On" or "Off".

Note: This option is only used in DTV mode.

OAD Scan

This option only used in DTV mode.

1. Press ▲/▼ button to select "OAD Scan" option.
2. Press OK button to search system software update file from DTV broadcast.

LNB Setting

1. Press ▲/▼ key to choose "LNB Setting" item.
2. Press "OK" button to display LNB Setting menu.

You can set specific setting to search DVB-S channels.

Note: This option is only used in DVB-S mode.

Menu system instruction

Function

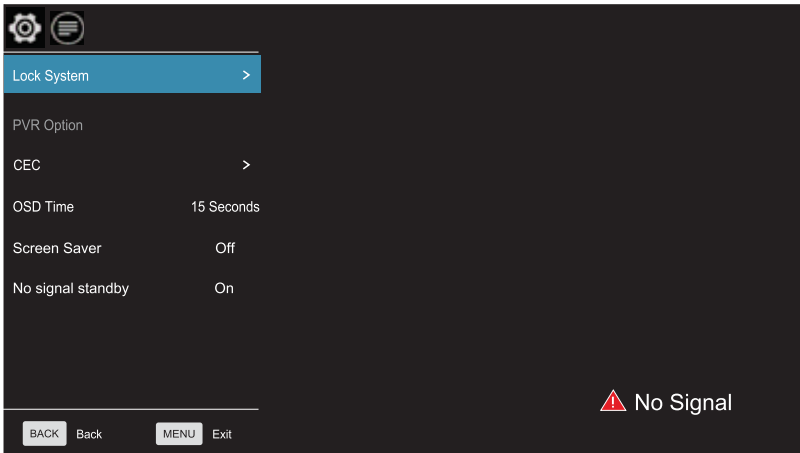

OSD Time: Set the preferred amount of time for the OSD to be displayed on the screen.

Lock (Optional)

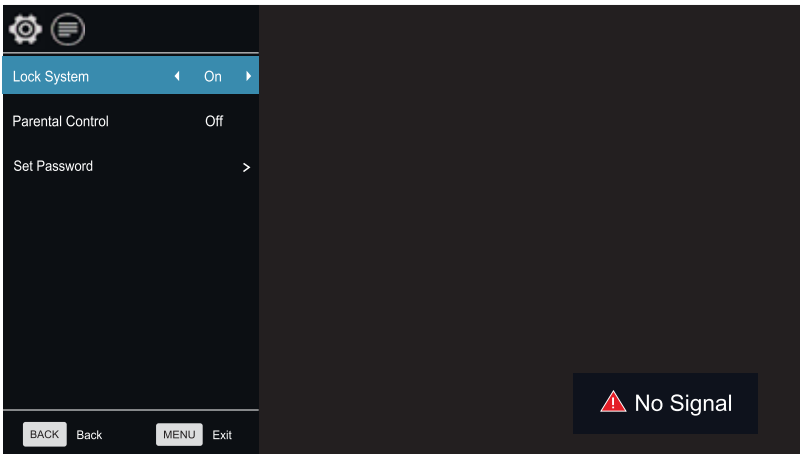

1. Press "Enter" key to select "System Lock" submenu.
2. Press ◀/▶ key to select "On" or "Off".

Menu system instruction

Function

Set Password

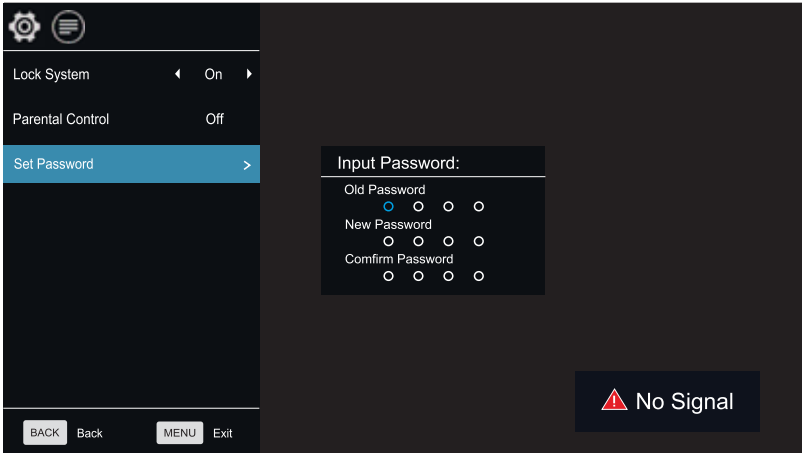

1. Press “OK” key to select "Set Password" option.
2. Enter your 4-digit password to set the old password. Choose any 4-digits for your new password and enter them. As soon as the 4 digits are entered, the cursor will skip to “Confirm password” item, re-enter the same 4 digits, and your new password has been memorized. (The default and universal password is 0000, the almighty password is 1980).

Parental Control

This option only used in DTV mode.

1. Press ▲/▼ button to select “Parental Control” option.
2. Press ◀/▶ button to select the lock level of the Parental Control.

CEC

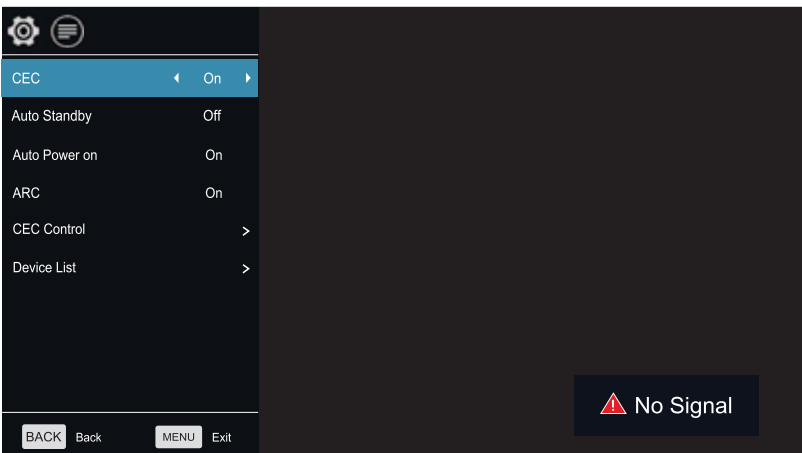

Menu system instruction

Function

Consumer Electronics Control (CEC) is an HDMI feature designed to allow the user to command and control up-to 15 CEC - enabled devices ,that are connected through HDMI, by using only one of their remote controls (for example by controlling a television set, set-top box, and DVD player using only the remote control of the TV).

1. Press ▲/▼ button to select “CEC” option.
2. Press OK button to enter “CEC” setting submenu.

This option is used to enable or disable CEC.

1. Press ▲/▼ button to select “CEC” option.
2. Press ◀/▶ button to select “On” or “Off”.

Auto Standby

This option is used when CEC function is enabled, and it judges weather the TV hander the standby command send from the device linked to it.

1. Press ▲/▼ button to select “Auto Standby” option.
2. Press ◀/▶ button to select “On” or “Off”.

Auto Power on

This option is used when CEC function is enabled, and it judges weather the TV hander the “Power on” command send from the device linked to it.

1. Press ▲/▼ button to select “Auto Power on” option.
2. Press ◀/▶ button to select “On” or “Off”.

ARC

This option is used when CEC function is enabled, it enables the TV send audio to the device linked to itself in HDMI mode.

1. Press ▲/▼ button to select “ARC” option.
2. Press ◀/▶ button to select “On” or “Off”.

Note: ARC is only available in HDMI1 MODE.

Device List

This option is used when CEC function is enabled, it lists the devices linked to the TV.

1. Press ▲/▼ button to select “Device List” option.
2. Press OK button to show the devices linked to the TV.

Menu system instruction

Function

CEC Control

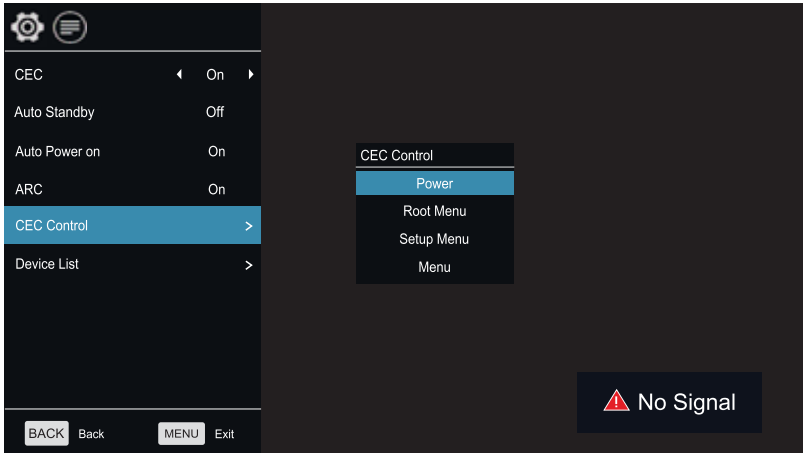

This option enables the TV to control the device linked to it.

1. Press ▲/▼ button to select “CEC Control” option.
2. Press OK button to enter the “CEC Control” submenu.

Power

1. Press ▲/▼ button to select “Power” option.
2. Press OK button to power off the device linked to the TV.

Root Menu

1. Press ▲/▼ button to select “Root Menu” option.
2. Press OK button to enter the root menu of the device linked to the TV.

Setup Menu

1. Press ▲/▼ button to select “Setup Menu” option.
2. Press OK button to enter the setup menu of the device linked to the TV.

Menu

1. Press ▲/▼ button to select “Menu” option.
2. Press OK button to enter menu of the device linked to the TV.

PVR Option

1. Press ▲/▼ button to select “PVR Option” option.
2. Press OK button to enter “PVR Option” submenu, for detailed operation refer to “PVR”.

No Signal StandBy

1. Press ▲/▼ button to select “No Signal StandBy” option.
2. Press ◀/▶ button to choose “On” or “Off”. If set “On”, TV will auto standby after 10 minutes in “No Signal” states.

(In VGA mode, if no any operation 15 seconds later, TV will enter standby mode.)

Menu system instruction

Function

Screen Saver

This option is only used in ATV mode.

1. Press ▲/▼ button to select “Screen Saver” option.
2. Press ◀/▶ button to select “On” or “Off”.

HDMI Edid Mode (Optional)

This option is only used in HDMI mode.

1. Press ▲/▼ button to select “HDMI Edid Mode” option.
2. Press ◀/▶ button to switch HDMI Edid Version.

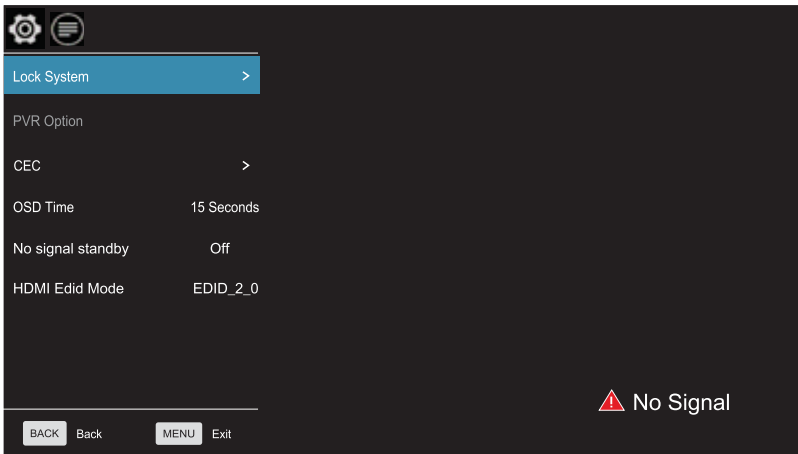

Time

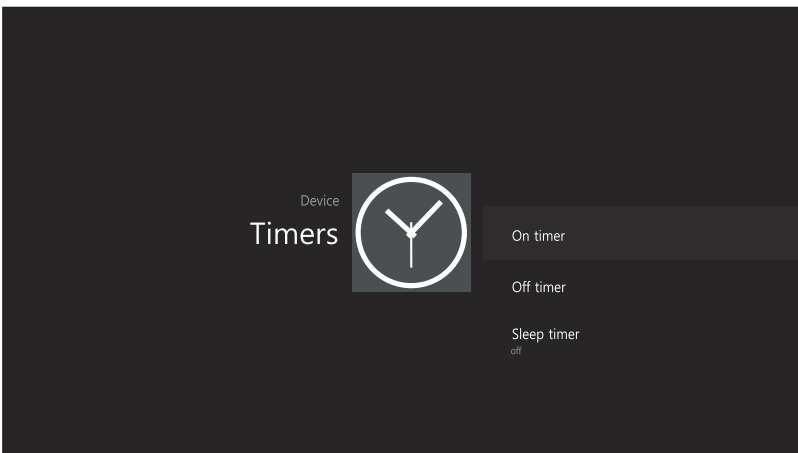

Menu system instruction

Time

On Timer

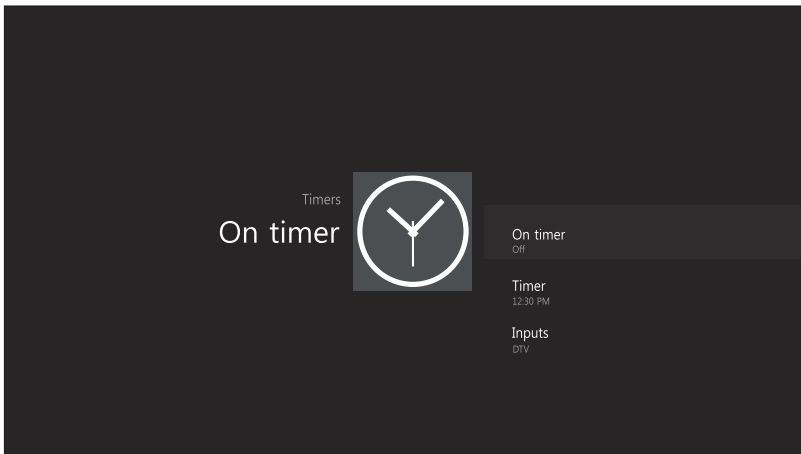

In "On Timer" item, press OK button to enter the submenu, set the time to turn on the TV set, when the TV set is in the standby mode. You can set a desired source to be displayed automatically when you start TV in "Source" menu.

Off Timer

In "Off Timer" item, press OK button to enter the submenu, set the time to turn off the TV set.

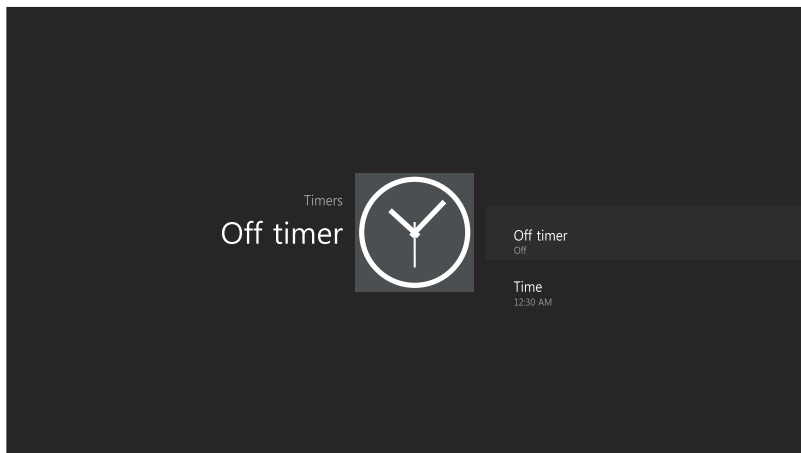

Menu system instruction

Time

Sleep Timer

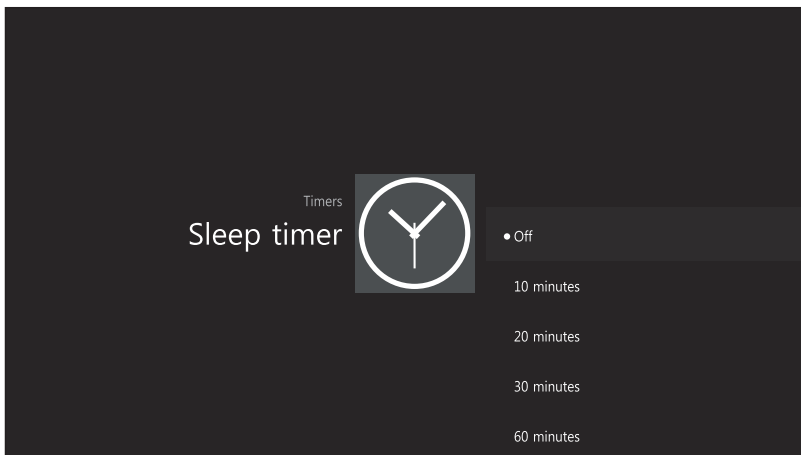

1. Press ▲/▼ key to select "Sleep Timer" option.
2. Press ◀/▶ key repeatedly until the desired time appears (Off, 10min, 20min, 30min, 60min, 90min, 120min, 180min, 240min).

Notes:

1. **The sleep timer you have set will be cancelled when the TV turns off or if a power failure occurs**
2. **When the time is up, remind information will be displayed on screen.**
Press any key button to cancel timer function.

Audio Language

1. Press ▲/▼ button to select "Audio Language" option.
2. Press ◀/▶ button to set Primary Audio Language.

Note: This option only used in DTV mode.

Subtitle Language

1. Press ▲/▼ button to select "Subtitle Language" option.
2. Press ◀/▶ button to set Primary Subtitle Language.

Note: This option only used in DTV mode.

PVR

WARNING:

1. Before connecting your USB device to the TV, please back up your files to prevent them from damage or loss of data.
2. A USB disk must be formatted when first used for PVR. Any existing data on the disk will be lost during the formatting process. Please back up your disk if you do not want to lose this data. You are recommended to use a dedicated disk for PVR use only. Do not disconnect disk or power during formatting.
3. Do not modify PVR files on a PC.

Note: Make sure your USB device is compatible with the TV and able to support PVR recording.

Menu system instruction

PVR

Select Disk: Press "OK" button to enter submenu and press "◀/▶" to choose the disk for PVR.

Time Shift Size: Press ◀/▶ to choose the size.

Format Disk: Press "OK" button to enter format submenu. The disk must be formatted when first used for PVR. Do not disconnect disk or turn power off during formatting. When formatting your disk, a progress bar will appear on the display.

Note: The larger your device the longer it will take to format. The device may take many minutes to format, this is not a malfunction, please wait for the formatting to finish.

Speed Check: Test your disk speed.

PVR Guide

If the disk for PVR is ready, the programs can be recorded in DTV mode.

PVR

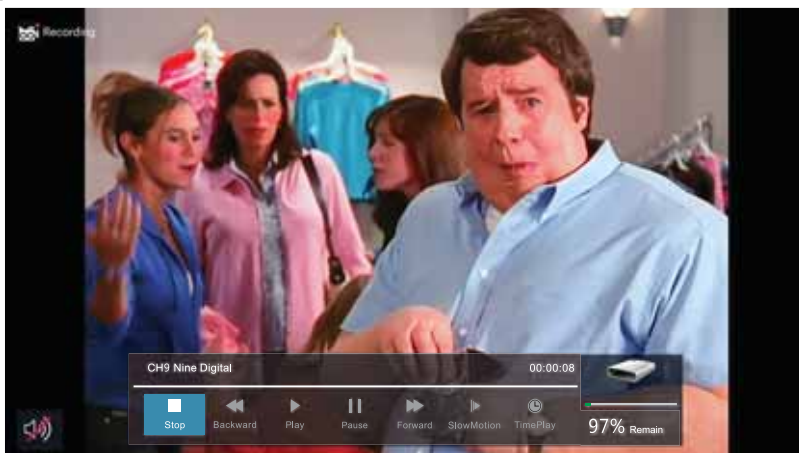

Time shift

In DTV mode, press ▶/|| button to pause the DTV program, press it again to continue play.

The length of time a program can be paused depends upon the setting in the PVR File System.

Press "BACK" to stop the time shift.

Press the PLAY button to continue playing the program from the point where it was paused.

Note: Time Shift will stop if you change channels, change inputs or go into standby mode while in Time Shift mode.

Instant recording

1. Select the desired channel then press the ● button on the remote control to start recording the current broadcast, a progress bar will be displayed at the bottom of the screen.

2. Recording stops when you press the BACK button and the recorded file is stored in the external USB device automatically.

Note: You can only watch channels on the same frequency as the program being recorded. If you try to change to another channel or come to the main interface a message will appear prompting you to continue or not "STOP RECORDING". System will stop record if user want to channel up/down, Confirm or Cancel.

Recording in standby mode

This unit is able to record while in standby mode.

Note: Start a recording then press the power button. A message will be displayed prompting you to standby, stop or cancel.

Menu system instruction

DTV

DTV EPG (Electronic Program Guide)

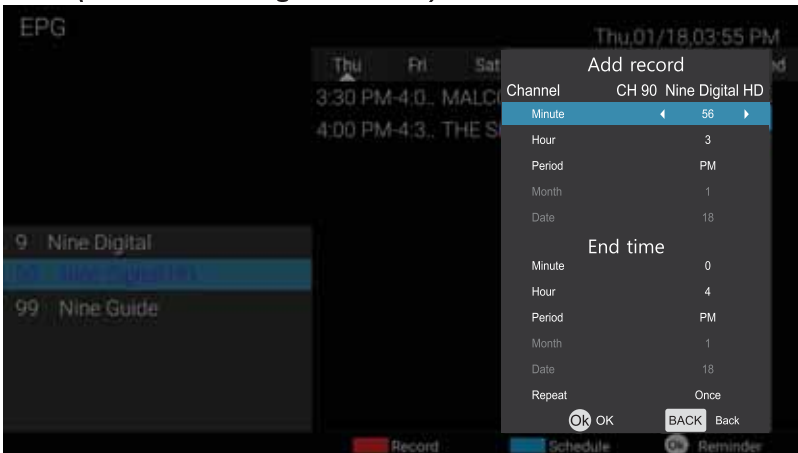

In DTV mode, press "GUIDE" button to enter the Electronic Program Guide. At Guide menu, press "RED" button to "Record" Setting.



At Guide menu, press "OK" button to "Reminder Settings". Note: Press ◀/▶ button to adjust the scheduled time, press "OK" button to save the setting.

Screen Shot

You can capture current picture by pressing Yellow button more than 1 second, and picture preview will automatically pop up if the capture succeeded. You can take the following picture as a reference.

Share to

When preview the captured picture, you can press OK button or choose by mouse to share it via Email, bluetooth to your friend, facebook, twitter etc. see the picture.

Note: This mode does not support bluetooth.

Reference

Troubleshooting

If you have any problem, check the counter measures for each symptom listed below. The following symptoms may have been caused by inappropriate adjustment rather than actual malfunction of the unit. If the trouble persists, contact the Customer Care Centre, see back page for contact details.

Symptoms	Possible solutions
No power	Please check the power cord plugged in and that the power outlet works. Unplug the power cord and plug it in after 60 seconds and restart the TV.
No picture	Please check antenna connection. Station may be experiencing problems, please tune to another station. Please adjust the settings of contrast and brightness.
Good picture but no sound	Please increase the volume. Please check TV is under mute mode, press MUTE button on the remote control. Please check sound settings If external devices are being used, check their volumes are not set too low or turned off. If using AVI or Component inputs, please make sure cables are connected properly and not loose. If using DVI to HDMI cable, a separate audio cable is required. Make sure a headphone jack is not connected..
Good sound but abnormal color or no picture	Please check antenna connection and antenna condition. If using Component input, please check Component connections, incorrect or loose connections may cause colour problems or cause the screen to be blank.
No response to remote control	Batteries of remote control may have exhausted, if necessary, please change the batteries. Clean the remote control lens. The distance between LED TV and remote control should be within 8m, within recommended operating angle and path is free of obstructions.
Full screen flickering under VGA	V-HEIGHT value may be set too big, restart computer and enter safe mode, then set monitor parameters to correct value according to adjustment description.
Horizontal stripes under VGA	Sample phase may be deflected, adjust phase according to picture position.
Colored dots may be present on the screen	Although the LED screen is made with high-precision technology and 99.99% or more of the the pixels are effective, black dots may appear or bright points of light (red, blue, or green) may appear constantly on the LED screen. This is a structural property of the LED screen and not a malfunction.
Picture is breaking up	Keep the TV away from noisy electrical sources such as cars, hair dryers, welders, and all optional equipment. Electrical atmospheric interference such as local or distant lightning storms may cause picture to break up. When installing optional equipment, leave some space between the optional equipment and the TV. Check the antenna and connection. Keep the antenna away from any power or input/output cables.

Reference

Troubleshooting

After Auto Tuning only some channels are available	Check your area is covered by Digital Video Broadcasts. Try re-tuning or manually tuning missing channels. Check that you are using the correct antenna type - please see pg.16 'Antenna connection'.
Channel cannot be selected	Check if the channel has been blocked in the main menu settings.
USB not playing	Please check connecting USB cable and power supply is connected. Hard drive has not been formatted. Please make sure USB disk is compatible and the multimedia data formats are supported.
Picture is distorted, macroblock, small block, dots, pixelization, etc	Compression of video contents may cause distortion especially on fast moving pictures such as sports and action movies.
Noise from speaker	Check cable connections, make sure a video cable is not connected to an audio input. Low signal level may cause sound distortion.
TV turns off automatically	Check if the Off Timer or Sleep timer is turned on.
TV turns on automatically	Check if the On Timer is set to On in the Setup menu.
Picture is not shown in full screen	First check if it is caused by the input signal. Then try to adjust Zoom in Function menu.

Picture defects and the reason



Snowy Picture

Snowy picture is usually due to weak signal. Adjust antenna or install an antenna amplifier.



Double Image or Ghosts

Double images are usually caused by reflections from tall buildings. Adjust the direction of the antenna or raise it.

Ghosting may also occur when still pictures are displayed continuously. It may disappear after a few moments.



Radio Wave Interference

Wave patterns are moving on the screen, which are usually caused by nearby radio transmitters or short-wave receiving equipment.



High Temperature Electrothermal Interference

Diagonal or herringbone patterns appear on the screen or part of picture is missing. This is probably caused by high temperature electrothermal equipment in a nearby hospital.



**LET'S LIVE
TOGETHER**