



GBR

SRB

# SL-124

OPERATING INSTRUCTIONS VACUUM CLEANER

UPUTSTVO ZA UPOTREBU USISIVAČ



GBR

# **INSTRUCTION MANUAL**

# **VACUUM CLEANER**

**MODEL: SL-124**

Please save and read this instruction manual carefully before use.

# VACUUM CLEANER

# INSTRUCTION MANUAL

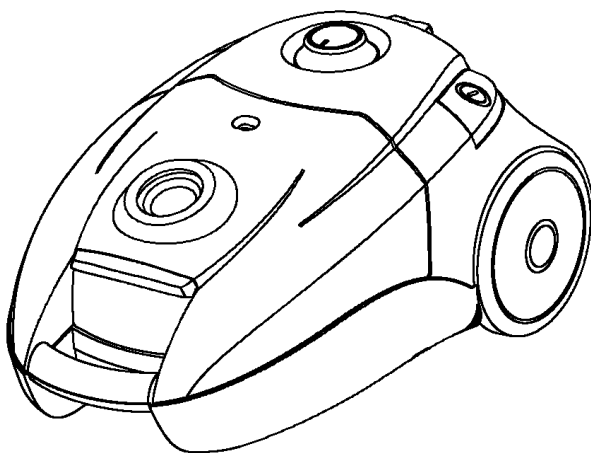

**SL124**

## IMPORTANT

1. Read this instruction booklet carefully.
2. Before using the appliance, check if the mains power voltage corresponds to the voltage shown on the rating plate.
3. The appliance should be connected to a correctly-earthed 10A power socket.
4. **Always remove the plug from the power socket when the appliance is not in use and before cleaning or maintenance.**
5. Always remove the plug from the power socket before opening the appliance.
6. Never use methylated spirits or other solvents for cleaning the appliance.
7. Do not use the appliance to vacuum liquids.
8. Never leave the appliance unattended when it is switched on. Keep the appliance out of the reach of children or the infirm.
9. **This appliance is only for household. Use as described in this instruction booklet.**
10. Do not switch the appliance on if it appears to be faulty in any way.
11. For repairs or accessories, contact your dealer or an authorized Service Center.
12. **If the supply cord is damaged, it must be replaced by the manufacturer, its service agent or similarly qualified persons in order to avoid a hazard.**
13. **This appliance is not intended for use by persons (including children) with reduced physical, sensory or mental capabilities, or lack of experience and knowledge, unless they have been given supervision or instruction concerning use of the appliance by a person responsible for their safety.**
14. **Children should be supervised to ensure that they do not play with the appliance.**

Do not remove the plug from the socket by pulling the cable or the appliance itself

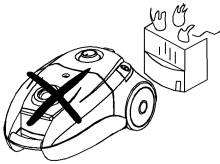

Do not run the appliance over the power cable

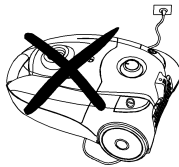

Do not use the appliance to vacuum lighted matches, cigarette ends or hot ash.



Do not use the appliance on wet surfaces



Do not obstruct the air intake or outlet vent

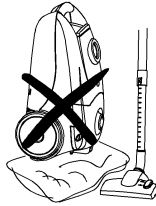

Do not use the appliance to vacuum needles, drawing pins or strings



## DESCRIPTION

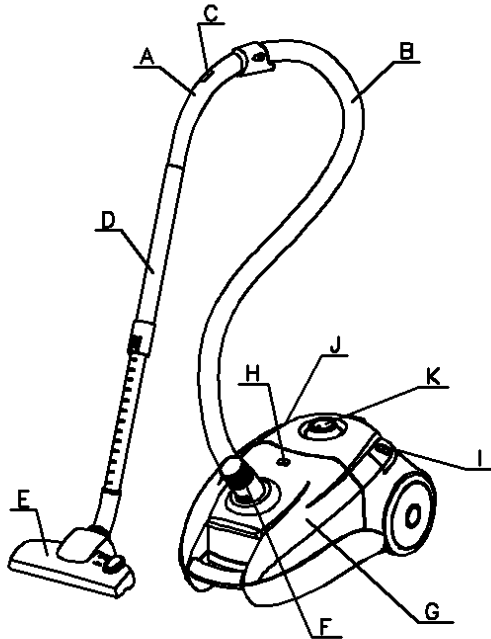

A. Handle  
E. Floor brush  
I. Power switch

B. Hose  
F. Hose connector  
J. Cable rewind button

C. Wind-force adjuster  
G. Front cover  
K. Speed controller

D. Tube  
H. Indicator

# ASSEMBLY

## Removing the flexible tube

Remove the plug from the power socket. To release the flexible tube, press the button on the end of the tube and pull the tube firmly from the air intake duct.

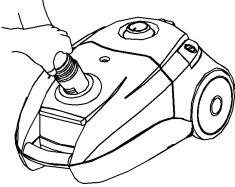

## Fitting the extension tubes and accessories

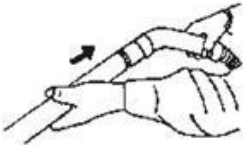

Fitting the extension tube to the handle

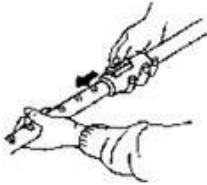

Fitting the extension tubes

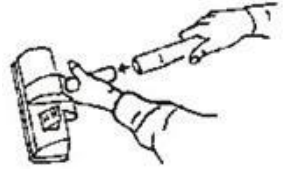

Fitting the accessories to the extension tube

# INSTRUCTION FOR USE

1. Before using the appliance, unwind length of cable and insert the plug into the power socket. The YELLOW mark on the power cable shows the ideal cable length. Do not extend the cable beyond the RED mark. To rewind the power cable, press the rewind button with one hand, and guide the cable with the other hand to avoid wrapping.
2. Press the ON/OFF button to switch the appliance on. It is advisable to set the electronic power regulator to MIN before switching the appliance on.
3. By turning the speed control knob, the absorption power can be adjusted.

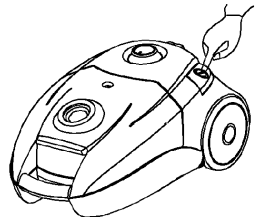
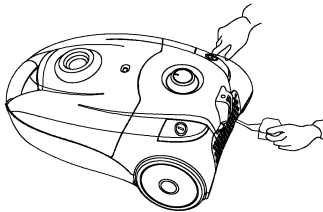
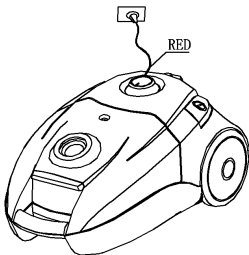

## ACCESSORIES

1. Dual-position carpet/floor brush



bristles extended for hard floors

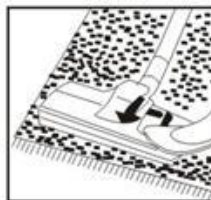

bristles retracted for carpets

2. Narrow nozzle (cleaning radiators, corners, edges, drawers etc)



3. Small brush (cleaning curtains, shelves, books, inlaid furniture, lamps and other delicate objects)



## REPLACING THE DUST BAG

1. After removing the flexible tube, open front cover by pressing the button and pulling upwards.
2. Remove the dust bag.

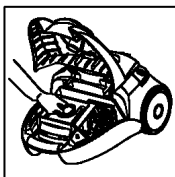
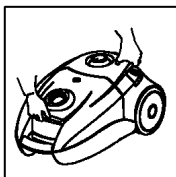

## MAINTENANCE

1. Pull the plug out of the socket before cleaning!
2. Clean the appliance with a dry cloth.

3. Take out the intake or outlet filter when it gets dirty. Clean it in warm water without any fluent and put it back when it is completely dry.
4. If you do not want to use this appliance for a period of time, store it on a dry and well ventilated place. Keep it out of reach of children.

## **DISPOSAL**

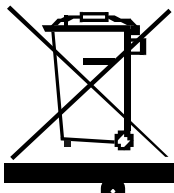

### **Environmental Protection**

Waste electrical production should not be disposed of with household waste. Please recycle where facilities exist. Check with your Local Authority or retailer for recycling advice.





SRB

**UPUTSTVO ZA UPOTREBU**

**USISIVAČ**

**MODEL: SL-124**

Pažljivo pročitajte ovo uputstvo pre korišćenja i sačuvajte ga za kasniju upotrebu

# USISIVAČ

## UPUTSTVO ZA UPOTREBU

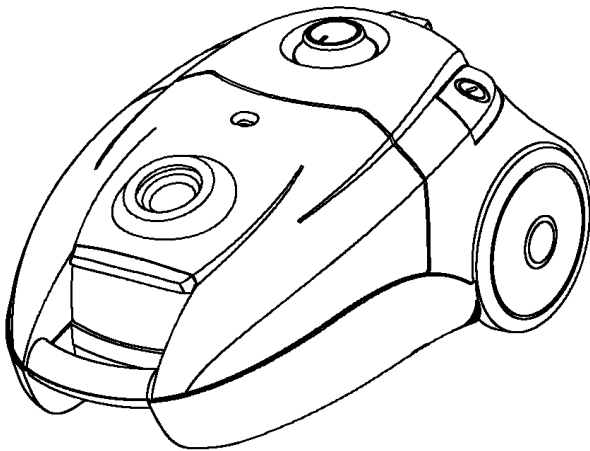

**SL124**

## VAŽNE INFORMACIJE

1. Pažljivo pročitajte ovo uputstvo.
2. Pre upotrebe uređaja, proverite da li napon u zidnoj utičnici odgovara naponu uređaja koji se može naći na natpisnoj tablici.
3. Uređaj treba da bude povezan sa ispravno uzemljenom utičnicom jačine 10A.
4. **Uvek isključite aparat i uklonite utikač ukoliko ne koristite aparat kao i pre čišćenja i održavanja uređaja.**
5. Uvek isključite utikač iz utičnice pre otvaranja uređaja.
6. Nikada nemojte koristiti metal-alkohol ili druge rastvore za čišćenje uređaja.
7. Nemojte koristiti uređaj za usisavanje tečnosti.
8. Nemojte nikada ostavljati uključen uređaj bez nadzora. Držite uređaj dalje od dece ili nejakih osoba.
9. **Uređaj je namenjen samo za kućnu upotrebu. Koristite ga kao što je opisano u uputstvu.**
10. Nemojte uključivati uređaj ukoliko je oštećen na bilo koji način.
11. Za bilo kakvu popravku ili zamenu delova, kontaktirajte Vašeg prodavca ili ovlašćeni Servisni centar.
12. **Ukoliko je naponski kabl oštećen, mora biti zamenjen od strane proizvođača ili njegovog ovlašćenog servisera ili druge kvalifikovane osobe kako biste izbegli rizik od povrede.**
13. **Ovaj uređaj nije namenjen osobama (uključujući decu) sa smanjenim fizičkim, senzornim ili mentalnim sposobnostima ili nedostatkom iskustva i znanja, osim ako nisu pod nadzorom ili su dobili uputstva u vezi sa upotrebom uređaja od strane osobe odgovorne za njihovu bezbednost.**
14. **Decu treba nadgledati da biste se uverili da se ne igraju s uređajem.**

Nemojte vaditi utikač iz utičnice povlačenjem kabla ili samog uređaja

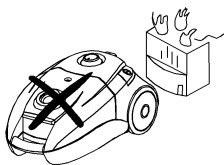

Ne postavljajte uređaj preko naponskog kabla.

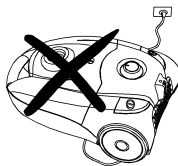

Nemojte koristiti uređaj za usisavanje korišćenih šibica, opušaka od cigareta ili vrućeg pepela.



Nemojte koristiti uređaj na mokrim površinama.



Ne sprečavajte slobodan protok vazduha kroz usisivač.

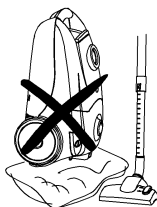

Nemojte usisavati igle, eksere i druge oštre predmete.



## OPIS DELOVA

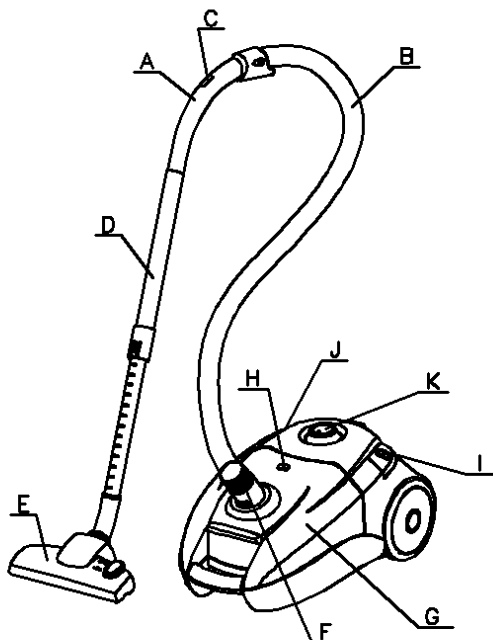

A. Ručka

B. Crevo

C. Poklopac na cevi

D. Cev

E. Četka za pod

F. Priključak cevi

G. Prednji poklopac

H. Indikator

I. Prekidač

J. Dugme za izvlačenje kabela

K. Kontrolisanje brzine

kabela

# SASTAVLJANJE USISIVAČA

## Odstranjivanje fleksibilnog creva

Isključite utikač iz utičnice. Da biste oslobodili fleksibilno crevo, pritisnite dugme koje se nalazi na kraju cevi i povucite ga čvrsto iz otvora za protok vazduha.

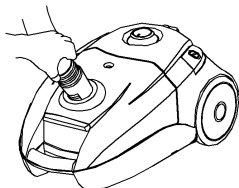

## Podešavanje cevi i dodataka

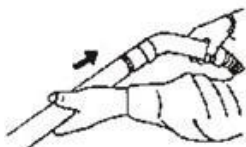

Sklapanje produžne cevi sa ručkom

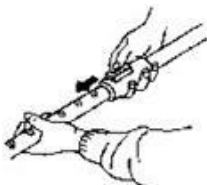

Sklapanje produžne cevi

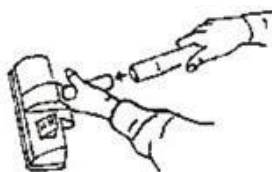

Spajanje dodatka sa produžnom cevi

## UPUTSTVO ZA UPOTREBU

1. Pre upotrebe uređaja, odmotajte celu dužinu kabla i ubacite utikač u zidnu utičnicu. ŽUTA oznaka na kablju pokazuje idealnu dužinu kabla. Nemojte izvlačiti kabl preko CRVENE oznake. Da biste izvukli naponski kabl, pritisnite dugme za odmotavanje jednom rukom, a drugom izvlačite kabl kako biste izbegli da se uvrne.
2. Pritisnite dugme ON/OFF da uključite uređaj. Preporučujemo da podesite elektronski regulator potrošnje na MIN pre nego što uključite uređaj.
3. Okretanjem regulatora za kontrolu usisavanja možete podesiti moć usisavanja.

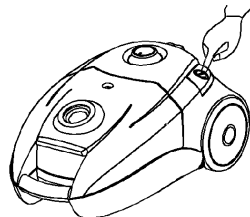
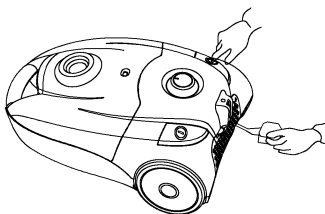
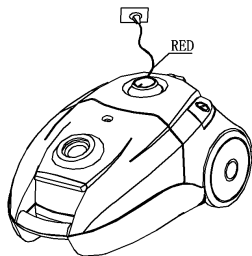

## Upotreba dodatka za čišćenje

1 Dva položaja četke tepih/pod.



Četkasti deo napolje za čvrste površine

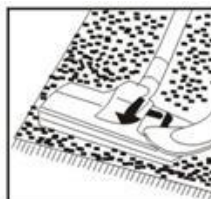

Četkasti deo unutra za tepihe

2. Uzani usisni dodatak (za čišćenje radijatora, čoškova, ivica. fioka itd)



3. Mala četka (za čišćenje zavesa, polica, knjiga, nameštaja, lampi i drugih osetljivih predmeta)



## ZAMENA KESE ZA PRAŠINU

1. Nakon uklanjanja produžne cevi, otvorite prednji poklopac pritiskom na dugme i podignite nagore.

2. Izvadite kesu za prašinu.

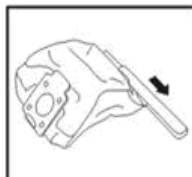
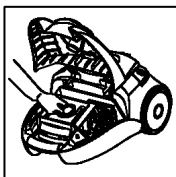
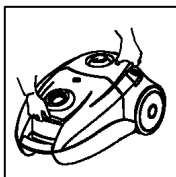

## ODRŽAVANJE

1. Izvucite utikač iz zidne utičnice pre čišćenja!

2. Čistite uređaj suvom krpom.

3. Izvadite filter motora kada je zaprljan. Operite ga toplom vodom bez deterdženta i vratite na mesto nakon što ga potpuno osušite.

4. Ukoliko neko vreme nećete koristiti uređaj, čuvajte ga u suvoj i dobro provetреноj prostoriji. Držite uređaj van domašaja dece.

## **ODLAGANJE**

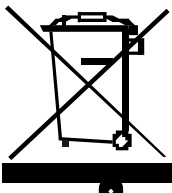

### **Zaštita životne sredine**

Elektronski otpad ne sme se odlagati zajedno sa otpadom iz domaćinstva. Reciklirajte na mestima predviđenim za ovu vrstu otpada. Raspitajte se kod vaših opštinskih vlasti ili kod prodavca o recikliranju ove vrste otpada.

