



GBR

SRB

SL-160

OPERATING INSTRUCTIONS VACUUM CLEANER

UPUTSTVO ZA UPOTREBU USISIVAČ



GBR

INSTRUCTION MANUAL

VACUUM CLEANER

MODEL: SL-160

Please save and read this instruction manual carefully before use.

VACUUM CLEANER

INSTRUCTION MANUAL

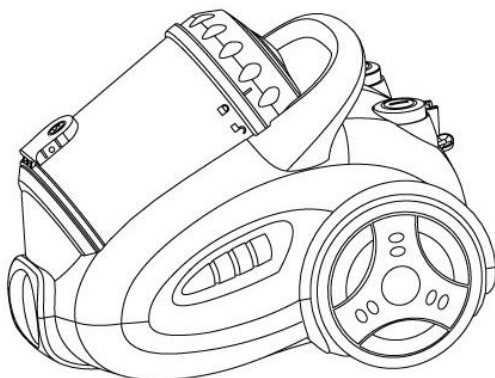

MODEL NO:SL-160

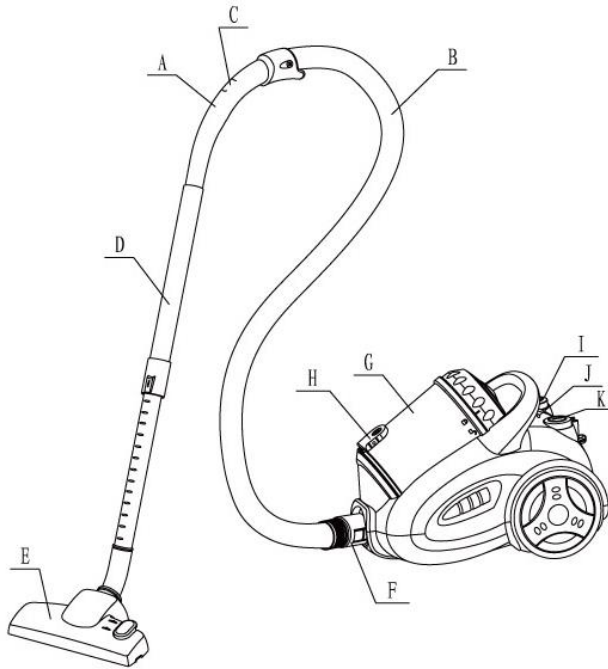

DESCRIPTION

- | | |
|------------------------|-----------------------|
| A. Handle | F. Hose connector |
| B. Hose | G. Dustbin |
| C. Wind-force adjuster | H. Dustbin button |
| D. Tube | I. Cord rewind button |
| E. Floor brush | J. Indicator |
| | K. Power switch |

IMPORTANT

1. Read this instruction booklet carefully.
2. Before using the appliance, check that the mains power voltage corresponds to the voltage shown on the rating plate.
3. The appliance should be connected to a correctly-earthed 10A power socket.
4. Always remove the plug from the power socket when the appliance is not in use and before carrying out any cleaning or maintenance operations.
5. Always remove the plug from the power socket before opening the appliance.
6. Never use methylated spirits or other solvents to clean the appliance.
7. Do not use the appliance to vacuum liquids.
8. Never leave the appliance unattended when it is switched on. Keep the appliance out of the reach of children or the infirm.
9. This appliances for domestic use only. Use as described in this instruction booklet.
10. Do not switch the appliance on if it appears to be faulty in any way.
11. For repairs or accessories. Contact your dealer or an authorized Service Center.
12. If the supply cord is damaged, it must be replaced by the manufacturer or its service agent or a similarly qualified person in order to avoid a hazard.
- 13. This appliance is not intended for use by persons (including children) with reduced physical, sensory or mental capabilities, or lack of experience and knowledge, unless they have been given supervision or instruction concerning use of the appliance by a person responsible for their safety.**
- 14. Children should be supervised to ensure that they do not play with the appliance.**

Do not remove the plug from by pulling the cable the or appliance itself



Do not run the appliance over the power cable



Do not use the appliance to vacuum lighted matches, cigarette ends or hot ash.



Do not use the appliance on wet surfaces.

Do not obstruct the air intake or outlet vent.

Do not use the appliance to vacuum needles, drawing -pins or string.

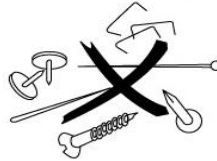
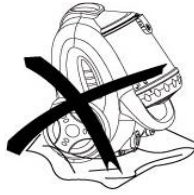

ASSEMBLING THE VACUUM CLEANER

Removing the flexible tube

Remove the plug from the power socket. To release the flexible Tube, press the button on the end of the tube and pull the tube Firmly from the air intake duct.

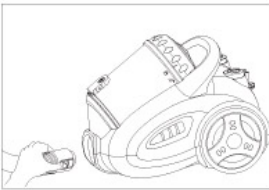

Fitting the extension tubes and accessories

Fitting the handle

Fitting the extension tubes

Fitting the accessories to the extension tube

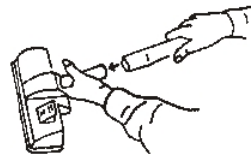
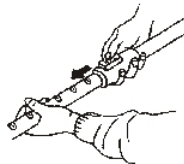
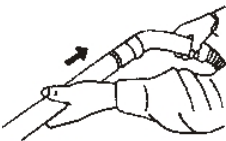

INSTRUCTION FOR USE

1. Before using the appliance unwind length of cable and insert the plug into the power socket. Do not extend the cable beyond the RED mark.
To rewind the power cable, press the rewind button with one hand, and guide the other hand to ensure that it does not whip causing damage
2. Press the ON/OFF button to switch the appliance on .

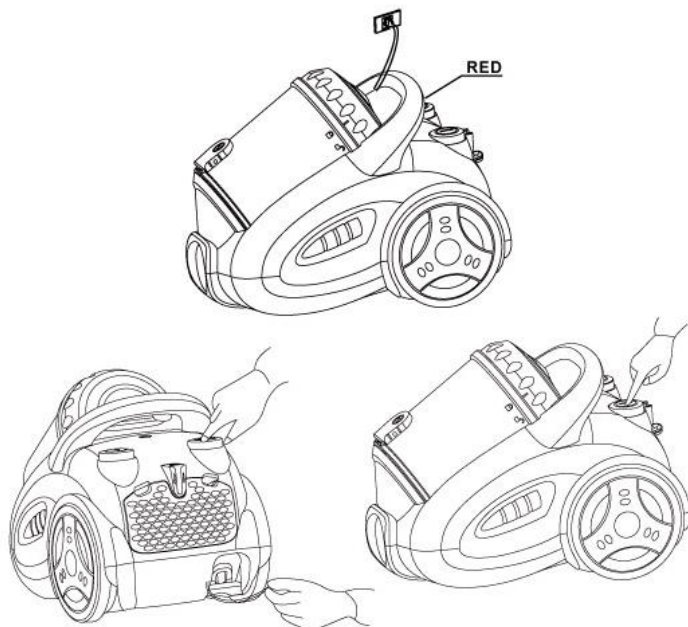

Using the cleaning accessories

- **Dual-position carpet/floor brush.**
Pos. 1: bristles extended for hard floors Pos. 2: bristles retracted for carpets

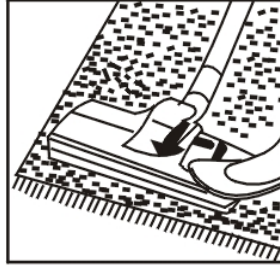

. Narrow nozzle.

for cleaning radiators: corners. edges. drawers etc.

Small brush

for cleaning curtains, shelves, books, inlaid furniture, lamps and other delicate objects.



Clean the dust

- 1,Lift the form cover and take out the dust cup.
- 2.Take out the foam form dust cup.
- 3.Clean off the dust inside the dust cup.

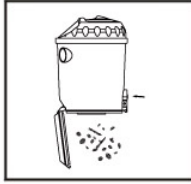
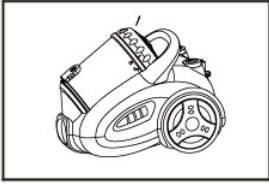

Clean the foam

1. Take out the foam when it gets dirty.
2. Clean it in the water. Dry it naturally before next use.

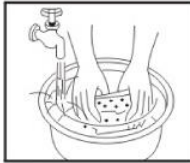
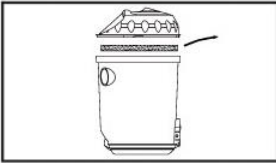

DISPOSAL

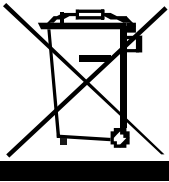

Environmental Protection

Waste electrical production should not be disposed of with household waste. Please recycle where facilities exist. Check with your Local Authority or retailer for recycling advice.



SRB

UPUTSTVO ZA UPOTREBU

USISIVAČ

MODEL: SL-160

Pažljivo pročitajte ovo uputstvo pre korišćenja i sačuvajte ga za kasniju upotrebu

USISIVAČ

UPUTSTVO ZA UPOTREBU

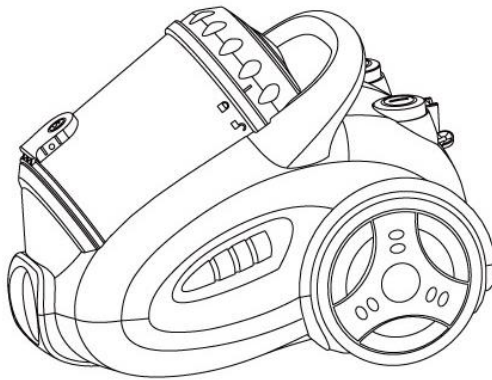

MODEL: SL-160

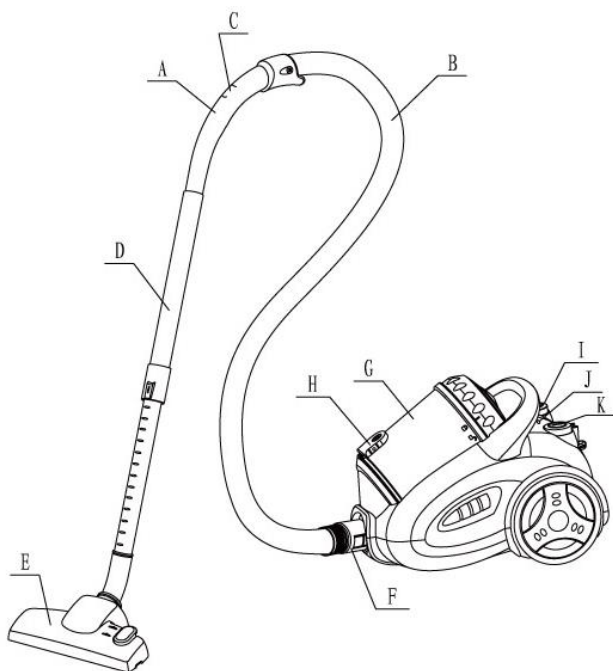

OPIS DELOVA

- | | |
|----------------------------|----------------------------|
| A. Ručka | F. Priključak creva |
| B. Crevo | G. Rezervoar za prašinu |
| C. Regulator snage vazduha | H. Dugme |
| D. Cev | I. Dugme za vraćanje kabla |
| E. Četka za čišćenje poda | J. Indikator |
| | K. Prekidač |

VAŽNE INFORMACIJE

1. Pažljivo pročitajte ovo uputstvo.
2. Pre upotrebe uređaja, proverite da li napon u zidnoj utičnici odgovara naponu uređaja koji se može naći na natpisnoj tablici.
3. Uređaj treba da bude povezan sa ispravno uzemljenom utičnicom jačine 10A.
4. **Uvek isključite aparat i uklonite utikač ukoliko ne koristite aparat kao i pre čišćenja i održavanja uređaja.**
5. Uvek isključite utikač iz utičnice pre otvaranja uređaja.
6. Nikada nemojte koristiti metal-alkohol ili druge rastvore za čišćenje uređaja.
7. Nemojte koristiti uređaj za usisavanje tečnosti.
8. Nemojte nikada ostavljati uključen uređaj bez nadzora. Držite uređaj dalje od dece ili nejakih osoba.
9. **Uređaj je namenjen samo za kućnu upotrebu. Koristite ga kao što je opisano u uputstvu.**
10. Nemojte uključivati uređaj ukoliko je oštećen na bilo koji način.
11. Za bilo kakvu popravku ili zamenu delova, kontaktirajte Vašeg prodavca ili ovlašćeni Servisni centar.
12. **Ukoliko je naponski kabl oštećen, mora biti zamenjen od strane proizvođača ili njegovog ovlašćenog servisera ili druge kvalifikovane osobe kako biste izbegli rizik od povrede.**
13. **Ovaj uređaj nije namenjen osobama (uključujući decu) sa smanjenim fizičkim, senzornim ili mentalnim sposobnostima ili nedostatkom iskustva i znanja, osim ako nisu pod nadzorom ili su dobili uputstva u vezi sa upotrebom uređaja od strane osobe odgovorne za njihovu bezbednost.**
14. **Decu treba nadgledati da biste se uverili da se ne igraju s uređajem.**

Nemojte vaditi utikač iz utičnice povlačenjem kabela ili samog uređaja



Ne postavljajte uređaj preko naponskog kabela.



Nemojte koristiti uređaj za usisavanje korišćenih šibica, opušaka od cigareta ili vrućeg pepela.



Nemojte koristiti uređaj na mokrim površinama.

Ne sprečavajte slobodan protok vazduha kroz usisivač.

Nemojte usisavati igle, eksere i druge oštre predmete.

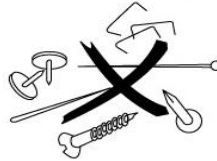
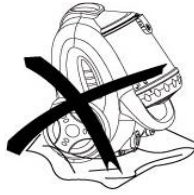

SASTAVLJANJE USISIVAČA

Odstranjivanje fleksibilnog creva

Isključite utikač iz utičnice. Da biste oslobodili fleksibilno crevo, pritisnite dugme koje se nalazi na kraju cevi i povucite ga čvrsto iz otvora za protok vazduha.

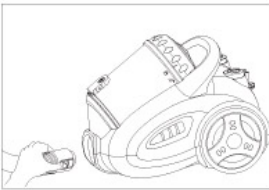

Podešavanje cevi i dodataka

Sklapanje produžne cevi sa ručkom

Sklapanje produžne cevi

Spajanje dodatka sa produžnom cevi

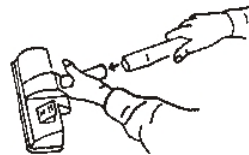
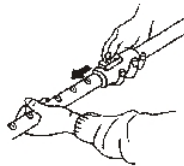
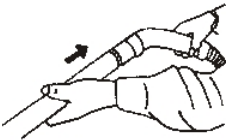

UPUTSTVO ZA UPOTREBU

1. Pre upotrebe uređaja, odmotajte kabl i uključite utikač u zidnu utičnicu. Nemojte izvlačiti kabl preko CRVENE oznake na njemu.

Da biste izvukli naponski kabl, pritisnite dugme za odmotavanje jednom rukom, a drugom izvlačite kabl kako biste izbegli da se uvrne.

2. Pritisnite dugme ON/OFF da uključite uređaj.

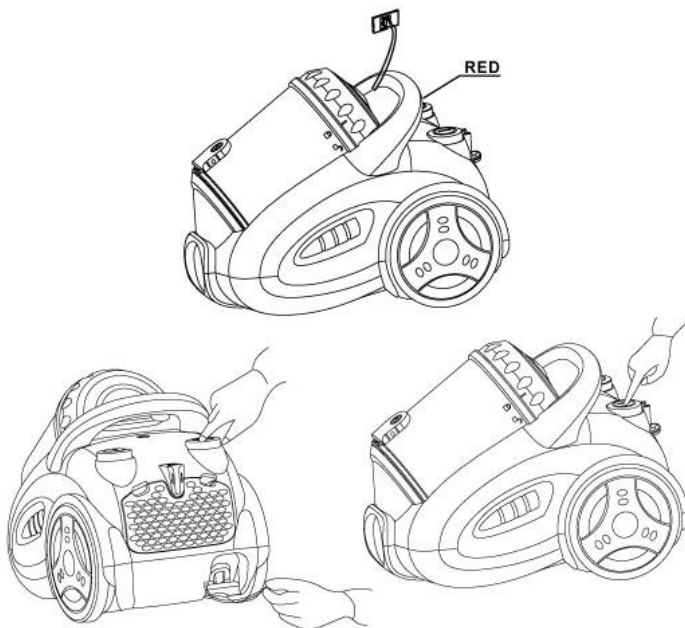

Upotreba dodatka za čišćenje

- Dva položaja četke tepih/pod.

Pozicija 1.

Četkasti deo napolje za čvrste površine



Pozicija 2.

Četkasti deo unutra za tepihe

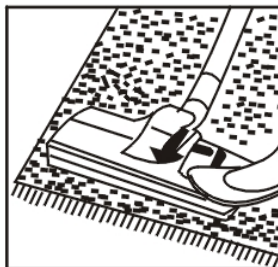

Uzani usisni dodatak

za čišćenje radijatora, čoškova, ivica, fioka itd.



Mala četka

za čišćenje zavesa, polica, knjiga, nameštaja, lampi i drugih osetljivih predmeta



Čišćenje usisane prašine

1. Podignite poklopac i uklonite rezervoar za prašinu.
2. Uklonite mekani penasti dodatak sa poklopca.
3. Uklonite prašinu unutar rezervoara.

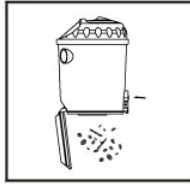
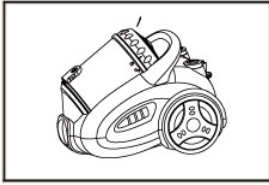

Čišćenje penastog filtera

1. Uklonite penasti filter kada se zaprlja.
2. Operite ga u vodi. Osušite ga u potpunosti pre sledeće upotrebe.



ODLAGANJE

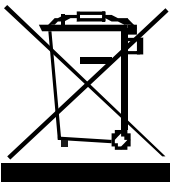

Zaštita životne sredine

Elektronski otpad ne sme se odlagati zajedno sa otpadom iz domaćinstva. Reciklirajte na mestima predviđenim za ovu vrstu otpada. Raspitajte se kod vaših opštinskih vlasti ili kod prodavca o recikliranju ove vrste otpada.

