



VOX
ELECTRONICS

ENG

OPERATING INSTRUCTIONS LED 32A11H672B

Important Safety Instructions and Maintenance

Important Safety Instructions

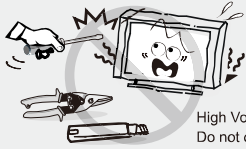

High Voltage
Do not open

CAUTION

Risk of electronic shock, do not open. Do not attempt to service this product yourself as opening or removing covers may expose you to dangerous voltage or other hazards. Refer all servicing to qualified service personnel.

To reduce the risk of fire or electric shock, do not expose this product to rain or moisture. The apparatus shall not be exposed to dripping or splashing and no objects filled with liquids, such as vases, shall be placed on the apparatus.



The screen and cabinet get warm when the TV is in use. This is not a malfunction. In case of smoke, strange noise or strange smell from the unit:

- Turn off the power switch immediately;
- Disconnect the power plug from the power outlet;
- Contact your dealer or service centre. Never attempt to make repairs yourself because this could be dangerous.

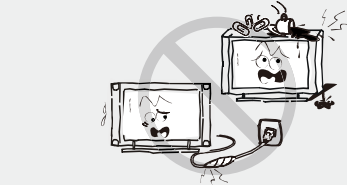

If the following problems occur:
Turn off the TV set and unplug the AC power cord immediately if any of the following problems occur. Ask your dealer or service centre to have it checked by qualified service personnel.

When:

- AC power cord is damaged.
- Poor fitting of AC power outlet.
- TV set is damaged by being dropped, hit or having something thrown at it.
- Any liquid or solid object falls through openings in the cabinet.

Never push objects of any kind into the set through the cabinet slots as they may touch dangerous voltage points or short-circuit parts that could result in a fire or electric shock. Never spill liquid of any kind on the set. Use special caution in households where children are present. The apparatus is not suitable for children under 3-year to operate.



Do not overload wall outlets, extension cords or adaptors beyond their capacity,

this can result in fire or electrical shock. Power-supply cords should be routed so that they are not likely to be walked on or pinched by items placed upon or against them, paying particular attention to cords at plug end, adaptors and the point where they exit from the appliance. The mains plug is used as the disconnect device. It shall remain readily accessible and should not be obstructed during intended use. Make sure to plug the power cord in until it is firmly inserted. When removing the power cord, make sure to hold the power plug when pulling the plug from the outlet, do not pull the plug out by the wire. NEVER touch the plug or power cord with wet hands. To disconnect the apparatus from the mains power, the plug must be pulled out from the mains socket, therefore make sure the mains plug is always easily accessible.



Do not push or scratch the front filter, or place any objects on top of the TV set. The image may be uneven or the screen may be damaged.

To avoid the fire, no naked flame source, such as lighted candles, should be placed on the apparatus.



Important Safety Instructions and Maintenance

Important Safety Instructions

An outside antenna system should not be located in the vicinity of overhead power lines or other electric light or power circuits, or where it can fall into such power lines or circuits. When installing an outside antenna system, extreme care should be taken to keep from touching such power lines or circuits as contact with them might be fatal. Ensuring the television is not overhanging the edge of the supporting furniture.

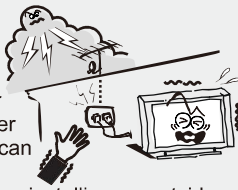

When not in use

If you will not be using the TV set for several days, the TV set should be disconnected from the AC mains for environmental and safety reasons. As the TV set is not disconnected from the AC power when the TV is turned off at the standby switch, pull the plug from the AC power outlet to disconnect the TV completely. However, some TV sets may have features that require the TV set to be left in standby to function correctly. In the case of lightning, unplug the TV set from the outlet immediately. Never touch the antenna wire during lightning.



Do not pull the plug out by the wire; Never touch the plug with wet hands.

Excessive volume from earphones and headphones can cause hearing loss.



Installation



The ventilation should not be impeded by covering the ventilation opening with items, such as newspapers, tablecloths, curtains, etc. At least 10 cm space should be left around the apparatus for sufficient ventilation.

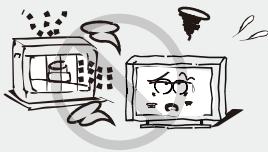

The product should be situated away from heat sources such as radiators, heat registers, stoves, or other products (including amplifiers) that produce heat. Place the apparatus in such a position that the screen is not exposed to direct sunlight. It is best to have soft indirect lighting while watching and avoid completely dark environments and reflection from the screen as these may cause eye fatigue. Keep the TV set away from any equipment emitting electromagnetic radiation.

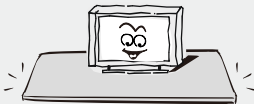

Do not place the set on an unstable cart, stand, table or shelf. The set may fall, causing serious personal injury as well as damage to the product. Use only with the cart, stand, tripod, bracket, or table specified by the manufacturer, or sold with the apparatus. An appliance and cart combination should be moved with care. Quick stops, excessive force, and uneven surfaces may cause the appliance and cart combination to overturn.



Do not place this apparatus near water, for example, near a bath tub, wash bowl, kitchen sink, or laundry tub; in a wet basement; or a swimming pool; and the like;

Important Safety Instructions and Maintenance

Installation



When the TV being moved in from cold place, it needs some right time for dew inside unit evaporating fully before turn on the unit;



To prevent injury, this apparatus must be securely attached to the floor/wall in accordance with the installation instructions.

LED Screen

Although the LED screen is made with high precision technology and 99.99% or more of the pixels are effective, black dots may appear or bright points of light (red, blue or green) may appear constantly on the LED screen. This is a structural property of the LED screen and is not a malfunction. If the surface of the LED panel cracks, do not touch it until you have unplugged the AC power cord. Otherwise electric shock may result. Do not throw anything at the TV set. The LED panel may break from the impact and cause serious injury.

Precautions When Displaying a Still Image

A still image may cause permanent damage to the TV screen.

Do not display still images and partially still images on the LED panel for more than 2 hours as it can cause screen image retention. This image retention is also known as "screen burn". To avoid such image retention, reduce the degree of brightness and contrast of the screen when displaying a still image.

Watching the LED TV in 4:3 format for a long period of time may leave traces of borders displayed on the left, right and centre of the screen caused by the difference of light emission on the screen. Playing a DVD or a game console may cause a similar effect to the screen.

Damages caused by the above effect are not covered by the Warranty.

Displaying still images from Video games and PC for longer than a certain period of time may produce partial after-images. To prevent this effect, reduce the 'brightness' and 'contrast' when displaying still images.

Cleaning

Cleaning and handling the screen surface and cabinet. Disconnect the unit from the AC outlet before cleaning. To remove dust, wipe gently with a soft, lint free cloth. If required use a slightly damp cloth.



MAINS PLUG

Wipe the mains plug with a dry cloth at regular intervals. Moisture and dust may lead to fire or electrical shock.



Use care not to subject the TV's surfaces to detergent. (A liquid inside the TV could lead to product failure, fire or electrical shock.) Use care not to subject surfaces to bug repellent, solvent, thinner, or other volatile substances as this may deteriorate the surface and finish of the cabinet.

Important Information

If a television is not positioned in a sufficiently stable location, it can be potentially hazardous due to falling. Many injuries, particularly to children, can be avoided by taking simple precautions such as:

- Using cabinets or stands recommended by the manufacturer of the television.
- Only using furniture that can safely support the television.
- Ensuring the television is not overhanging the edge of the supporting furniture.
- Not placing the television on tall furniture (for example, cupboards or bookcases) without anchoring both the furniture and the television to a suitable support.
- Not standing the televisions on cloth or other materials placed between the television and supporting furniture.
- Educating children about the dangers of climbing on furniture to reach the television or its controls.
- Keep small accessories out of reach of children so they are not mistakenly swallowed.

Table of Contents

Accessories	5
Introduction	6
Features.....	6
Specifications.....	7
Stand and wall-mounting instructions (optional)	8
General Description	9
Overview of front panel.....	9
Overview of back panel.....	10
Overview of remote control.....	11
Installing Batteries in the Remote Control.....	13
External Connection	13
Antenna connection.....	13
Basic operation	14
Turning the TV on and off.....	14
Source	15
TV Menu	15
Picture	15
Sound	16
Channel	16
Media part	19
Android part	20
Home	20
Settings.....	20
Network	21
Sound	21
Apps	21
reset.....	22
Troubleshooting	23

Please make sure the following items are included with your LED TV. If any items are missing, contact your dealer.

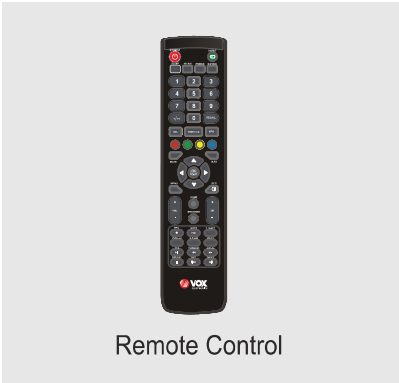

Introduction

Features

- . TV adopts 32" TFT LED display screen
- . Zero X radiation complies to green environment protection requirement
- . Connect to computer directly to realize TV/monitor combo.
- . Support USB
- . 16:9 wide screen
- . Auto tuning and fine tuning
- . Support HDMI
- . Programmable sleep timer
- . Wide range voltage input
- . No-signal automatic power off

Input terminals used for external equipment connection

- 1x RJ45 Input
- 2x USB Input
- 1x Earphone Output
- 2x HDMI Input
- 1x COAXIAL
- 1x AV Input
- 1x Mini YPbPr Input
- 2x RF Input
- 1x CI

Introduction

Specifications

Model	LED 32A11H672B
Display size	32" Diagonal(max.)
LED panel resolution	1366X768
Speaker output power	2x5W
Power supply	100-240V~, 50/60Hz
TV receive system	Digital: DVB-T/T2 , DVB-C, DVB-S/S2 Analog: PAL/SECAM
Frequency range	48.25~863.25MHz
Video in	PAL/SECAM
Power consumption	55W
Standby consumption	<0.5W
Antenna Input	75 ohms, unbalanced
Controller power	DC 3V (Two AAA size batteries)
Work Temperature	0°C-40°C

NOTES:

- Design and specifications are subject to change without notice.

Stand and wall-mounting instructions (optional)

How to assemble the stand

If you need to remove or assemble the stand please read the following instructions.

-Before attaching/detaching the stand, make sure to turn off the TV.

-Before performing work, spread cushioning over the base area to lay the LED TV on. This will prevent it from being damaged.

Assembling instruction:

Step1: Take out two stands from package, and insert them into bottom of TV;

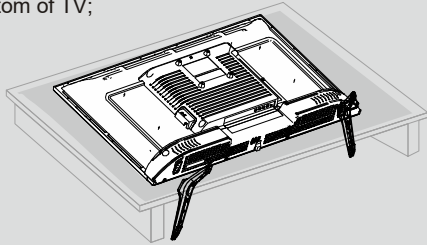

Step2: Take out four screws provided with TV set and tighten them into screw holes;

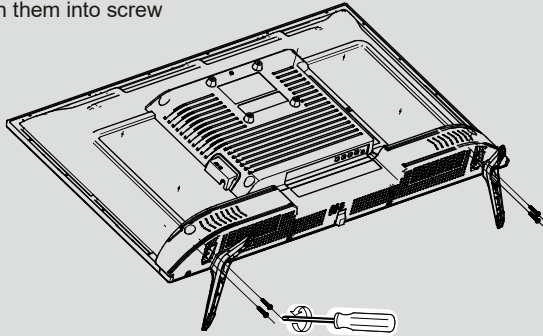

Screws
32" (4 x B-ST4*20)

- To disconnect the stand from the TV, perform the above steps in reverse order.

General Description

Overview of front panel

The buttons on the lower-right panel control your TV's basic features, including the on-screen menu. To use the more advanced features, you must use the remote control.

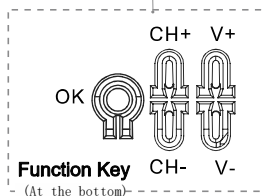
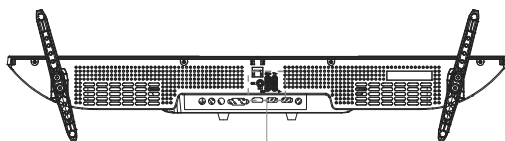

1 OK

Short press to call out MENU when no menu display. Short press to confirm at any menu. Long press to enter standby mode.

2 CH+

CH-

CH+/-: Select channel.

3 V+

V-

VOL+/-: Adjust Volume.

General Description

Overview of back panel

You can connect the TV with video devices such as DVD/VCD player, VCR and video camera to enjoy the high quality picture.

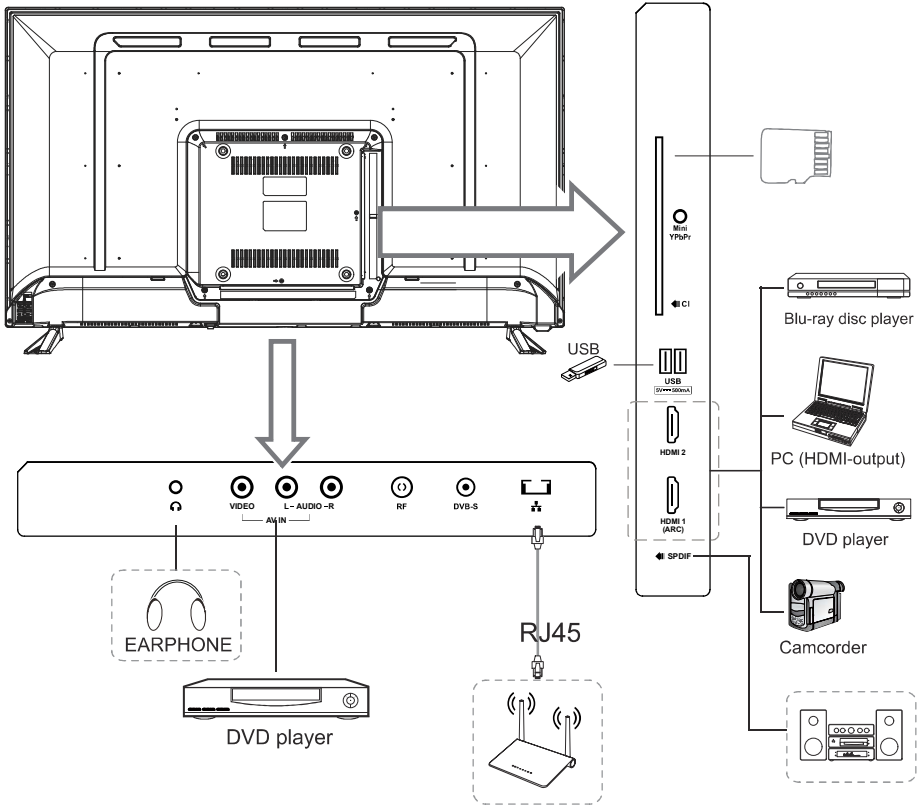

General Description

Overview of Remote Control

REMOTE CONTROL OUTLOOK & FUNCTION KEY DEFINITION

1. **【POWER】** Press this button to switch to standby mode, and press it again to turn TV on.
2. **【INPUT】** Press to select the input source.
3. **【S.MODE】** This button is used to select the sound mode.
4. **【P.MODE】** This button is used to adjust user picture mode, press this button repeatedly and select one of four settings.
5. **【NICAM】** The button is used to set NICAM sound system. **Note** : Nicam function is optional, the button on the remote control is only available with certain models.
6. **【SLEEP】** Let you select amount of time before your TV turn itself off automatically.
7. **【0-9】** Press 0-9 to select a TV channel directly when you are watching TV. To enter page number in teletext mode and so on.
8. **【--/--】** Press this button to enter a program number with different digits.e.g.--for1,--for11,---for111.
9. **【RECALL】** Switch back and front between the current and previous channels.
10. **【DEL】** Delete button.
11. **【SUBTITLE】** Press to switch the subtitles at the bottom of the screen.
12. **【EPG】** Enter electronic program guide.(used only in DTV mode)
13. **【RED, GREEN, YELLOW, CYAN】** Correspond to the different menu item colours.
14. **【MUTE】** Press this button to shut off sound of the TV temporarily, press again to restore TV sound.
15. **【INFO】** The button is used to display current channel information.
16. **【▲/▼/◀/▶/ENTER】** Allows you to navigate the on-screen menus and adjust the system settings to your preference.
17. **【MENU】** Brings up the LCD main menu to the screen in TV mode.
18. **【EXIT】** Press EXIT to exit menu or sub menu.
19. **【VOL +/-】** Press to increase / decrease the sound level.
20. **【HOME】** Press the button to back to the home page screen.
21. **【PROG +/-】** Press to scan through or to select a channel.
22. **【BROWSER】** Press this button to enter the website.
23. **【T.SHIFT】** Press the button to pause current DTV program and start record background. (used only in DTV mode)

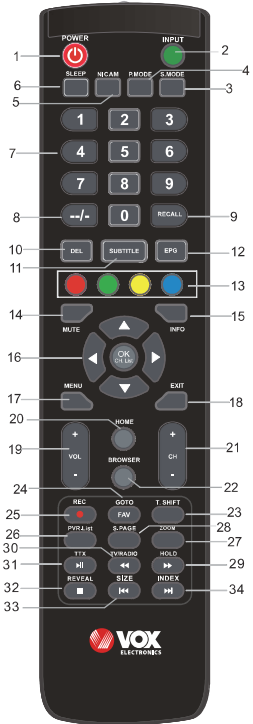

General Description

Overview of Remote Control

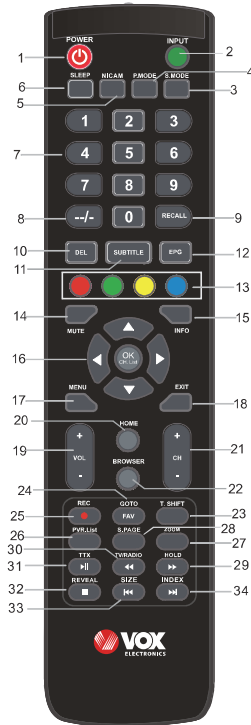

24. **[GOTO]** Skip
- [FAV]** Favourite program channel.
25. **[REC]** Start to record.(used only in DTV mode)
26. **[PVR.List]** Display the list burn. (used only in DTV mode)
27. **[ZOOM]** This button is used to set display window.
28. **[SUBPAGE]** Press SUBPAGE to enter sub coded page of teletext.
29. **[HOLD]** Hold on or off for current page display.
[◀/▶] Press to timeshift or play a program in fast rewind mode.
30. **[DTV/RADIO]** In the DTVsource,press is to enter Radio channel and press it again to enter DTV channel.
31. **[TTX]** Press this button to open or close teletext
Note: Teletext function is optional, the button on the remote control is only available with certain models.
[▶||] Play/pause or begin to timeshift.
32. **[REVEAL]** Press REVEAL to show or hide the hidden information of teletext (depending on broadcasting.)
[■] Stop playing or stop recording.
33. **[SIZE]** Adjust the screen image display ratio.
[◀◀] Press to go to the previous chapter.
34. **[INDEX]** Press the button to display content page of teletext.
[▶▶] Press to go to the next chapter.

General Description

Installing Batteries in the Remote Control

Installing Batteries

1 Open the battery compartment cover on the back side.

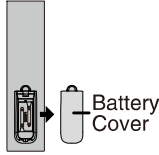

2 Insert two 1.5V AAA size batteries in correct polarity. Don't mix old or used batteries with new ones.

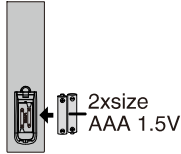

3 Closed the cover.

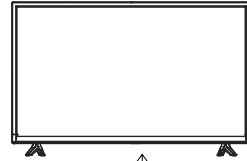
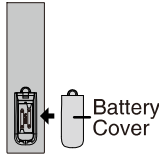

30° 30°



† Point the remote towards the remote control sensor of the TV and use it within 8 meters.

† Put the used batteries into the recycling bin since they can negatively affect the environment.

NOTES:

- One loading of batteries will last for 1 year under normal use.
- If you do not intend to use the remote controller for a long period of time, remove them to avoid damage due to leakage.
- Do not use old and new batteries together.
- The batteries (battery pack or batteries installed) shall not exposed to excessive heat such as sunshine, fire or the like.

External Connection

Antenna connection

Antenna input impedance of this unit is 75ohm. VHF/UHF 75ohm coaxial cable can be connected to the antenna jack directly, if the antenna cable is 300ohm parallel flat feeder cable, you need to use the 300ohm/75ohm converter to connect the antenna cable to the antenna jack. For details Please refer to the following drawing.

Antennas with 300 Ω flat twins Leads

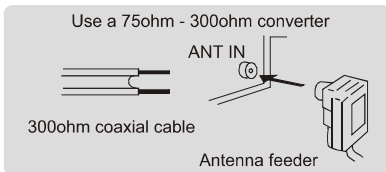

Antennas with 75 Ω Round Leads

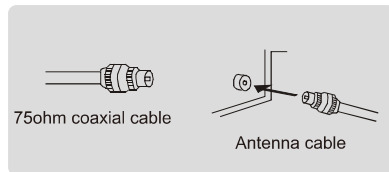

Basic Operation

Turning the TV On and Off

How to turn the TV on or off

1. Insert the power cord plug into a polarized AC outlet.
2. If TV is in standby mode, press **POWER** button on the remote control or ⏻ button on the back panel of LED TV.
3. Normal picture will be displayed on the screen after 10 seconds. If no signal input, "No Signal" will be displayed on the screen.
4. If temporary POWER off is required, press POWER button on the remote control or ⏻ button on the back panel.
5. If you want to completely switch off the power for this unit, unplug the power cord plug for this unit.
6. After switching off the unit, you should wait at least 5 seconds before switching on again.

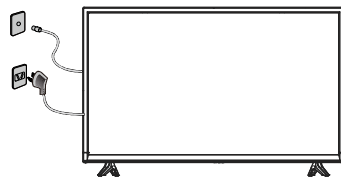

Status indication lamp

Red: In standby mode.

Green: In power on mode.

Auto power-off

1. If there is no signal, the TV will automatically enter standby mode after 10 minutes.

Memory before turning TV off

The picture and sound settings and preset channels will be memorized at the point when the TV is turned off. When the TV is started up again it will work accordingly with these settings.



SOURCE

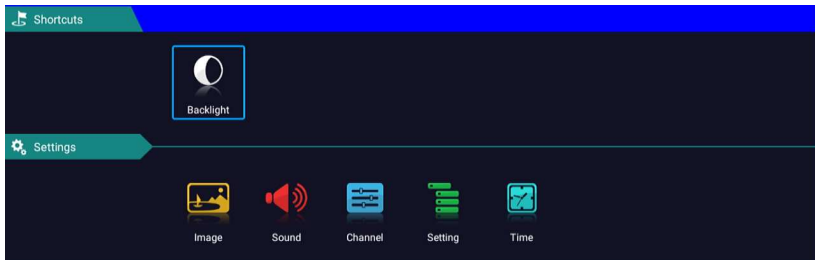

(According to the "source" button to display the input source menu, select the corresponding input signal source by the next button, press the confirm button you can enter the relevant signal source.)

TV MENU



Press the  menu  button to display the menu, press the up and down keys to select the appropriate settings, press the right button to enter the relevant settings.

Picture

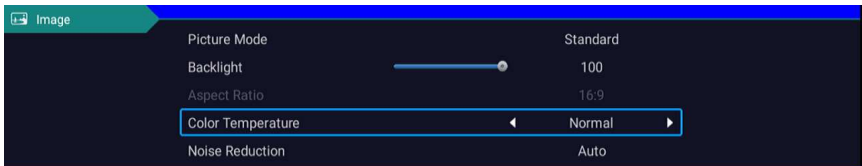

Picture Mode

Choose the picture menu with left and right keys, and press OK button for next operation. Then the up and down arrows can be used to select this item. The picture mode can be switched to standard/soft/lightness/user.

Aspect Ratio

You can select ZOOM1, ZOOM2, 16:9 or 4:3 with left and right keys when the option of Aspect Ratio is picked. The aspect ratio will automatically change in auto mode.

Color temperature

Select the option of color temperature by the above-mentioned way, then change its setting with left and right keys. The color temperature can be cold, nature, warm, user mode.

Noise Reduction

Press up/down key to select "Noise Reduction" option. Press left/right key to select "Off", "Weak", "Middle", "Strong" and "Auto" to improve the picture sharpness.

Sound

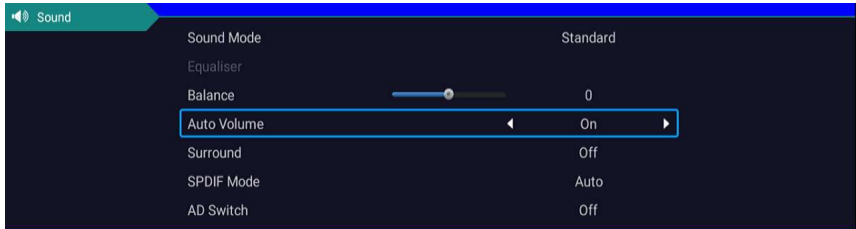

Sound mode

Select the sound menu by using the up and down keys, press the right click "sound mode" option, and press the left and right buttons to switch the sound mode to music / movie / motion / user.

Equalizer

Through the up and down keys selected "equalizer" option, and then press the OK key system will appear different bandwidth frequency level.

Balance

If the volumes of the left speaker and the right speaker are not the same, you can adjust the "Balance" to suit your personal preference.

Auto Volume - Surround

Select the automatic volume control options, after the key about to open or close the automatic volume control function, this method is also suitable for adjusting the surround sound.

SPDIF Mode

This is used to select "SPDIF Mode". This option is only used in HDMI/DTV mode.

Channel



DVB-T Auto Search

Select option of Auto Tuning under the up and down keys . Then press OK button and the auto tuning will begin.

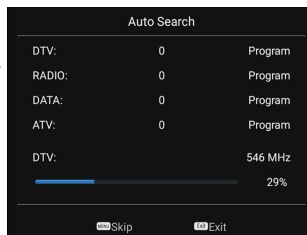

DTV Manual Search

To simulate manual search, select the Channel you need to store, and also select the color and sound system. Press the up and down keys to select the "Search" option, press the left and right button to search, and you can modify the frequency by fine tuning , choose the best frequency.

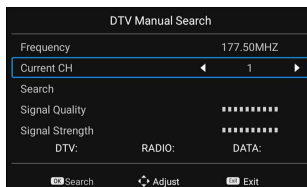

Channel Edit

Select the signal information option, press OK key to enter the next interface, will show the strength of the signal.

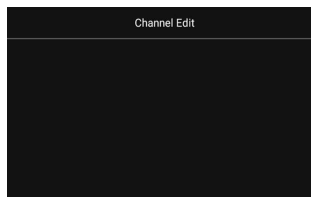

Setting Adjustment

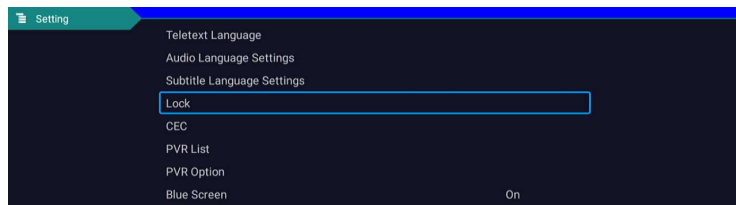

Press the "menu display time" option, through the left and right direction keys can be changed to 5 seconds, 10 seconds, 15 seconds, 20 seconds, 30 seconds, always optional

CEC

Press up and down key to select the option, and then open or close by the left and right CEC function. When cec opens, you can choose to turn on or off Auto Standby, Auto Power on, ARC, Device List, TV shutdown, cec devices will also automatically shut down.

Rest

Select the "restore default settings" option by using the up and down keys, and then click OK to enter the next window. Can choose to confirm or cancel, choose to confirm the television will restart, the menu data will restore the initial data, choose to cancel also back to the menu interface.

Time setting



Date, Current time

This is not adjustable, when there is a signal when the automatic calibration.

Sleep time

The system provide many options of sleep time.

Lock

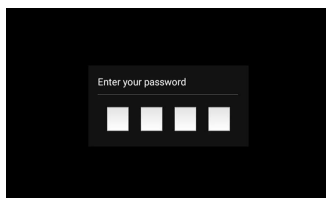
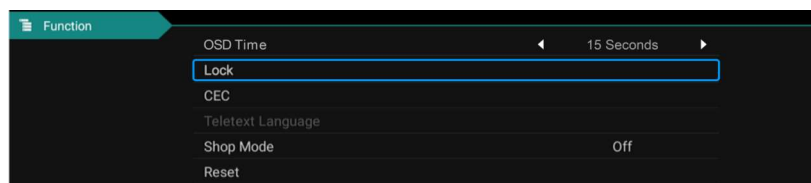

Choose the option of Lock System with the up and down keys .Then open the lock function with left and right keys. Please remember that initial password is 0000.If you want to adjust password, you firstly should select option of set password and then input old password, new password. When new password you input again is correct and make sure above operation, this mean that you successfully reset password. When you want to shield some programs you don't like, please select the option of block program and input the channel number

Media part

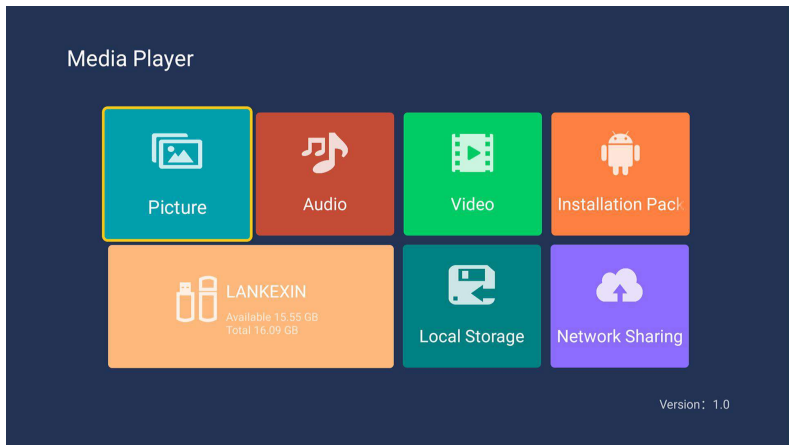

Picture

Through the up and down keys to select the "picture" icon, press the confirmation button to confirm, and then press right to the folder, press the confirmation button to open the appropriate folder. After selecting the picture, press the confirmation key to open the picture, can carry on some operation through the left and right keys.

Music

Through the up and down keys to select the "song" icon, press the confirmation button to confirm, and then press right to the folder, press the confirmation button to open the appropriate folder. After selecting the song, press the confirmation key to open the song, you can make some operation through the left and right keys.

Video

Through the upper and lower keys selected "video" icon, press the confirmation key to confirm, then press right to the folder, press the confirmation key to open the corresponding folder. After the selection of the video, press the confirmation key to open the video, you can make some operation through the left and right.

Android part

Home

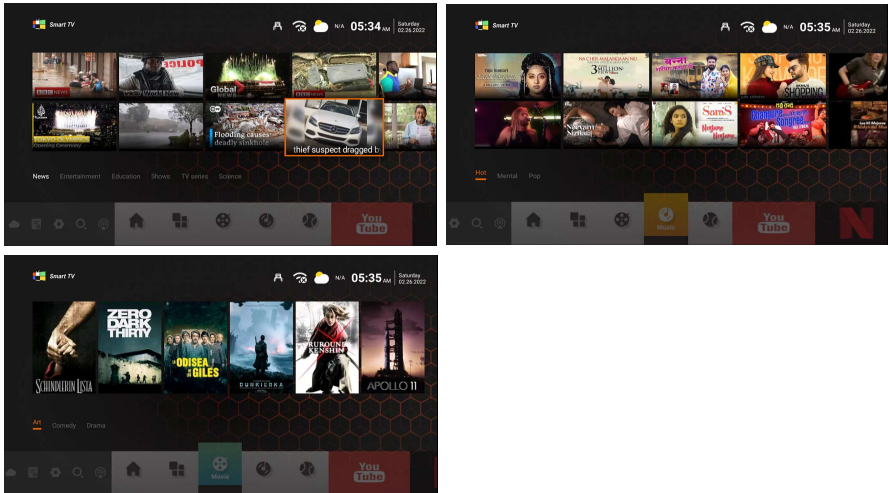

The main page uses Zeasn UI design and is divided into: WHAT'S NEWS, APPS, MUSIC, APORTS

*Different regions will receive different push content

Settings

Pick the image of setting and Press OK button to appear the interface of the android setting.

The following is a brief description of the function of each menu.

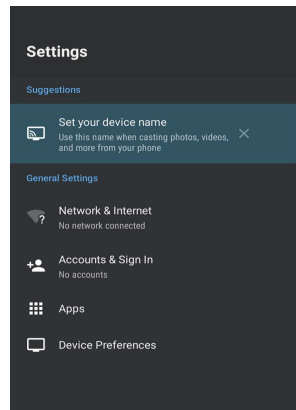

Network

Enter the "Network" menu item "Wi-Fi", you can open or close the Wi-Fi connection function, there are 4 types of connection: select focus and enter the password in the list of connections, use without-password protected connection, manually add hot name to connect, and point-to-point direct connection.

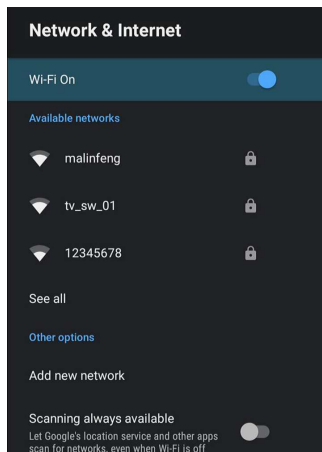

Sound

Set key tone

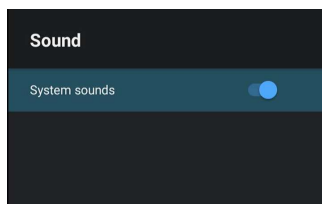

Apps

In the menu, you can view the application of the installation, running applications and all of the application.

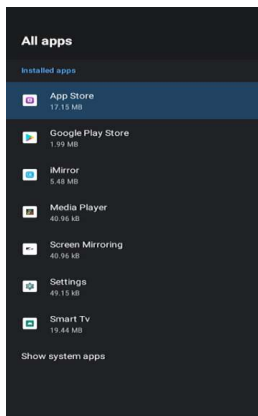
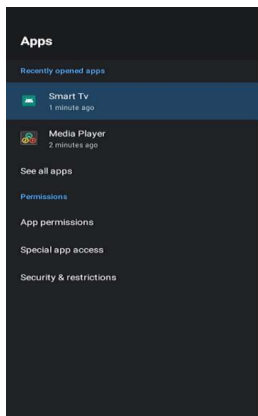

reset

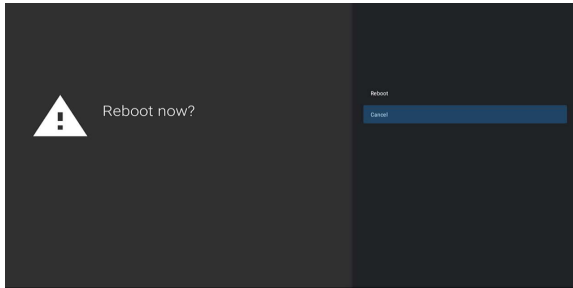

Here you can view the details of the internal storage space and the use of SD card , and in the option of backup& reset, you can do factory data reset . After resetting, the data on TV will be erased. For system update

About

You can view and set the relevant information for the OTA update, you can also view the model, Android version,version number information.

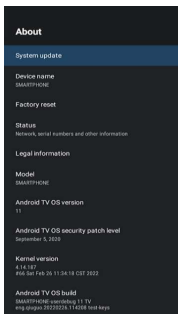

Language

System language can be selected here.

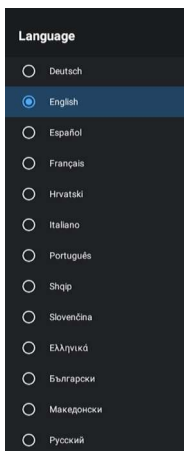

Date & Time

In this part, you can modify the date and time, and also choose to synchronize with the date &time of the network.

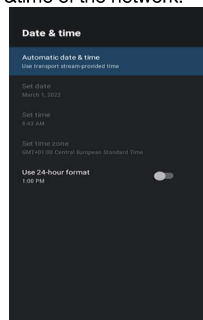

Keyboard

Users can be based on personal preferences of the keyboard input settings, you can also view the personal dictionary.

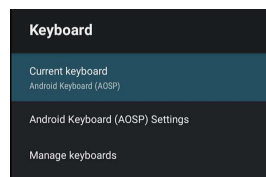

Troubleshooting

If you have any problem, check the counter measures for each symptom listed below. The following symptoms may have been caused by inappropriate adjustment rather than actual malfunction of the unit. If the trouble persists, contact the Customer Care Centre, see back page for contact details.

Symptoms	Possible solutions
No power	<p>Please check the power cord plugged in and that the power outlet works.</p> <p>Unplug the power cord and plug it in after 60 seconds and restart the TV.</p>
No picture	<p>Please check antenna connection.</p> <p>Station may be experiencing problems, please tune to another station.</p> <p>Please adjust the settings of contrast and brightness.</p>
Good picture but no sound	<p>Please increase the volume.</p> <p>Please check TV is under mute mode, press MUTE button on the remote control.</p> <p>Please check sound settings</p> <p>If external devices are being used, check their volumes are not set too low or turned off.</p> <p>If using DVI to HDMI cable, a separate audio cable is required.</p> <p>Make sure a headphone jack is not connected..</p>
Good sound but abnormal color or no picture	<p>Please check antenna connection and antenna condition.</p> <p>If using Component input, please check Component connections, incorrect or loose connections may cause colour problems or cause the screen to be blank.</p>
No response to remote control	<p>Batteries of remote control may have exhausted, if necessary, please change the batteries.</p> <p>Clean the remote control lens. The distance between LED TV and remote control should be within 8m, within recommended operating angle and path is free of obstructions.</p>
Full screen flickering under VGA	<p>V-HEIGHT value may be set too big, restart computer and enter safe mode, then set monitor parameters to correct value according to adjustment description.</p>
Horizontal stripes under VGA	<p>Sample phase may be deflected, adjust phase according to picture position.</p>
Colored dots may be present on the screen	<p>Although the LED screen is made with high-precision technology and 99.99% or more of the pixels are effective, black dots may appear or bright points of light (red, blue, or green) may appear constantly on the LED screen. This is a structural property of the LED screen and not a malfunction.</p>
Picture is breaking up	<p>Keep the TV away from noisy electrical sources such as cars, hair dryers, welders, and all optional equipment.</p> <p>Electrical atmospheric interference such as local or distant lightning storms may cause picture to break up.</p> <p>When installing optional equipment, leave some space between the optional equipment and the TV.</p> <p>Check the antenna and connection.</p> <p>Keep the antenna away from any power or input/output cables.</p>

Troubleshooting

After Auto Tuning only some channels are available	Check your area is covered by Digital Video Broadcasts. Try re-tuning or manually tuning missing channels. Check that you are using the correct antenna type.
Channel cannot be selected	Check if the channel has been blocked in the main menu settings. It is available when the TV has channel block function.
USB not playing	Please check connecting USB cable and power supply is connected. Hard drive has not been formatted. Please make sure USB disk is compatible and the multimedia data formats are supported.
Picture is distorted, macroblock, small block, dots, pixelization, etc	Compression of video contents may cause distortion especially on fast moving pictures such as sports and action movies.
Noise from speaker	Check cable connections, make sure a video cable is not connected to an audio input. Low signal level may cause sound distortion. Sleep Timer may have been enabled. If there is no signal for about 15 minutes from an input, the TV will turn off.
TV turns off automatically	If connected to your PC, check your PC power settings. Make sure the AC power cord is plugged in securely to the wall outlet and the TV.
Picture is not shown in full screen	Black bars on each side will be shown on HD channels when displaying SD (4:3) contents. Black bars on Top & Bottom will be shown on movies that have aspect ratios different from your TV. Adjust picture size option on your external device or TV to full screen.

WARNING

Never place a television set in an unstable location. A television set may fall, causing serious personal injury or death. Many injuries, particularly to children, can be avoided by taking simple precautions such as:

- Using cabinets or stands recommended by the manufacturer of the television set.
- Only using furniture that can safely support the television set.
- Ensuring the television set is not overhanging the edge of the supporting furniture.
- Not placing the television set on tall furniture (for example, cupboards or bookcases) without anchoring both the furniture and the television set to a suitable support.
- Not placing the television set on cloth or other materials that may be located between the television set and supporting furniture.
- Educating children about the dangers of climbing on furniture to reach the television set or its controls

If your existing television set is being retained and relocated, the same considerations as above should be applied.

The plug or appliance coupler is used as the disconnect device, the disconnect device shall remain readily operable.

