



VOX
ELECTRONICS

ENG



OPERATING INSTRUCTIONS UHD 50ADW-FFL

Contents

Safety Warning and Notice	1
Mounting and Connecting	3
Packing list.....	3
Mounting the TV set.....	3
Connecting peripheral equipment.....	4
Panel Control Keys	5
Remote Control	5
Basic Operations	7
Turning on/Standby.....	7
Signal source selection.....	7
Menu operation description.....	7
Program scanning.....	7
REC option.....	8
Time Shift option.....	8
Instructions for Intelligent Platform Operation	8
Basic Operations.....	8
Quick Start.....	8
Smart Applications.....	9
Network Settings.....	10
Hotel Function.....	10
Important Statement on Network Services	10
Troubleshooting	11
Technical Specifications	11
Use of a TV wall mounting	13
Base Installation Instructions	13

Safety Warning and Notice

Thanks for choosing the high-performance and multifunctional intelligent LED TV produced by our company. This precious thing will bring you better audiovisual enjoyment. The design of this product has given consideration to factors affecting personal safety, and the product itself has gone through strict tests prior to delivery. However, improper operation may result in electric shock and fire disaster. To ensure safety, prolong the service life of this product, and make sure the best performance of this product can be given full play to, please read the manual and marking label carefully before using it and comply with the following safety instructions. Please keep the user manual for later use.

 Warning	May result in casualties
	Indicate the behaviors that must be prohibited
 Attention	May result in personal injury or property losses

	Indicate the operations that must be performed
---	--

Under Following Conditions

- Power failure or unstable voltage.
- Abnormal sound or smell from the device.
- AC power cord is damaged.
- TV set is damaged due to falling off, knock or impact.
- Any liquid or foreign matters enter into the TV set.

Turn off the TV set immediately, unplug the power cord from the power outlet, and contact authorized maintenance personnel.

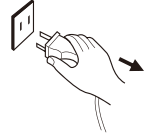



- If coal gas or other flammable gases leak, do not unplug the power cord of the TV set or other electric appliances; instead, close the valve of the gas immediately and open the doors and windows.

Warning

-  ● Only use 100-240VAC, 50/60Hz power supply.
- All cables can be connected or pull out only after power supply is turned off.
- Do not fix the TV set on instable position, or else it may cause falling off, damage, or even fire.
- Do not put the TV set in the environment:
 1. With direct sunshine, moisture, overheating, undercooling or heavy dust;
 2. With flammable or explosive substance;
 3. With flammable or corrosive gas;
 4. In bathroom, kitchen, etc.
- Do not use damaged or improper power socket, and ensure that the plug and socket are connected properly.
- Keep the power plug and socket free of dust and metal pieces.
- Do not damage the power cord:
 1. It is prohibited to refit the power cord;
 2. Do not put heavy object on the power cord;
 3. Keep the power cord away from heat source;
 4. Do not drag the power cord when unplugging.
- Do not connect too many appliances to one power strip, or else it may cause fire

Warning

- due to high power consumption.
 - Do not let open flame (e.g. lit candle) approach the TV set, or else it may cause electric shock or fire.
 - Do not put the container filled with water on the TV set, to avoid electric shock or fire caused by water drop or splashing.
 - Do not penetrate any sharp object, metal or liquid into the signal connector or air vents, to avoid short circuit and product damage as well as electric shock.
 - The slots on the case is designed to release heat so as to assure that all inside components will not reach an extra high temperature and can work normally for a long time. Please do not cover the holes while place it.
-  Do not touch the plug with wet hands, or else it may cause electric shock.
-  Do not turn on the TV set in thunderstorm weather; instead, unplug the power plug and antenna connector to avoid lightning strike.
-  Do not disassemble the TV set by yourself, or else it may cause electric shock or fire. Contact qualified personnel for maintenance.

Attention

- Do not let children climb onto the TV set.
- Keep the small accessories away from children's reach to avoid swallowing.
- If the TV set won't be used for a long time, please turn off the device and unplug the power cord.
- Before cleaning the TV set, unplug the power cord and wipe with soft cloth; do not use chemical reagents and avoid foreign substances entering into the device. The incorrect cleaning (such as cleaning fluid, water, etc) may lead to damage of product's appearance, erasing products printing information, even flow into the machine and damage components, cause machine can not display.

Attention

- To adjust the position or angle of the TV set, please disconnect all wires and move slowly to avoid falling off.
- Do not rub with hard object, knock at, bend or squeeze the screen.
- Do not use machine immediately after transferring machine to the places with high temperature from low temperature, which will cause fogging inside machine and failures.
- If the screen is broken and the liquid splashes on skin, please wash with clean water immediately for 15 minutes, and go to see your doctor.
- To carry the TV set with hands, please grasp the corners and hold the bottom; do not apply force on the panel.
- Displaying the same image for a long time or active image with fixed words, icons will leave "image persistence" on screen which will not disappear after powering off for a long time. This undesirable phenomenon is not covered by warranty.
- Healthy TV watching:
 1. Watch in appropriate light; poor light or long time watching may hurt your eyes.
 2. Adjust the volume appropriate to avoid hurting your hearing.
- Unplug the power cord of the device to cut off the power supply.
- If a power plug or appliance coupler is used as disconnecting device, it should ensure easy operation.
- Power plug shall be connected reliably. Loose power plugs may cause sparkle and fire.
- All the technical specifications in the user's manual and on the packaging are subject to changes without prior notice. If there is slight deviation between the user's manual and actual operation, the latter shall prevail.

HDMITM
HIGH-DEFINITION MULTIMEDIA INTERFACE

The terms HDMI and HDMI High-Definition Multimedia Interface, and the HDMI Logo are trademarks or registered trademarks of HDMI Licensing Administrator, Inc. in the United States and other countries.



Android is a trademark of Google LLC. The Android robot is reproduced or modified from work created and shared by Google and used according to terms described in the Creative Commons 3.0 Attribution License.

Mounting and Connecting

Packing list

1. The TV set.
2. User Manual.
3. Remote control.
4. Power cord (or attached to TV set).

Mounting the TV set

Tips on Installation

- The TV set should be mounted near the AC power socket for easy plugging and unplugging.
- For your safety, please select appropriate wall mount bracket or base.
- To avoid hurt, it is required to place the TV set on stable plane, or fix on firm wall.
- Ask qualified personnel to mount the TV set on the wall. Improper mounting may result in instable TV set.
- Do not place the TV set at any place susceptible to mechanical vibration.
- Do not place the TV set at any place that insects may enter.
- Do not mount the TV set against air conditioner, or else the internal panel of the display may condense moisture and cause failure.
- Do not place the TV set at any place with strong magnetic field, or else it may be interfered with and damaged by electromagnetic wave.

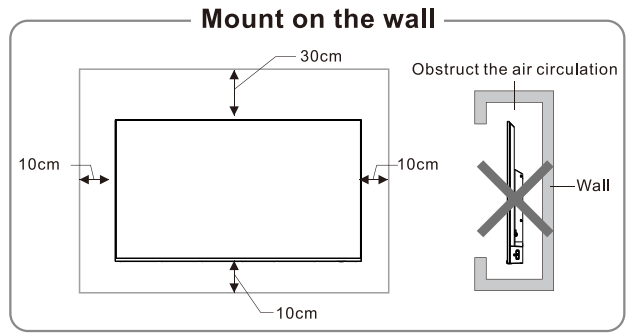

Ventilation

- Please keep this space at least around the TV, as shown in the figure.
- Do not cover the air vents or insert any object into the enclosure.
- Do not put the device in limited space, e.g. bookcase or embedded closet, unless the TV set is properly ventilated.

Warning

Never place a television set in an unstable location. A television set may fall, causing serious personal injury or death. Many injuries, particularly to children, can be avoided by taking simple precautions such as:

- Using cabinets or stands recommended by the manufacturer of the television set.
- Only using furniture that can safely support the television set.
- Ensuring the television set is not overhanging the edge of the supporting furniture.
- Not placing the television set on tall furniture (for example, cupboards or bookcases) without anchoring both the furniture and the television set to a suitable support.
- Not placing the television set on cloth or other materials that may be located between the television set and supporting furniture.
- Educating children about the dangers of climbing on furniture to reach the television set or its controls.

If your existing television set is being retained and relocated, the same considerations as above should be applied.

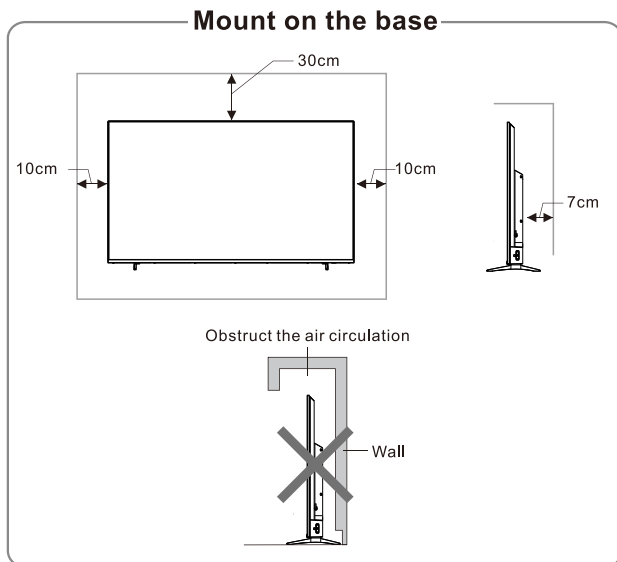

Connecting peripheral equipment

Remark:

1. USB interfaces support peripheral equipment, including USB mass storage device, USB mouse, keyboard, etc.
2. When you need to connect the device which support the ARC function, please select the HDMI-1 interface.
3. HDMI connector can realize DVI connector function with external HDMI/DVI commutator.
4. TV2(DVB-S2) interface is optional, please refer to the device.
5. The peripheral equipment and cables described in this manual should be purchased separately.

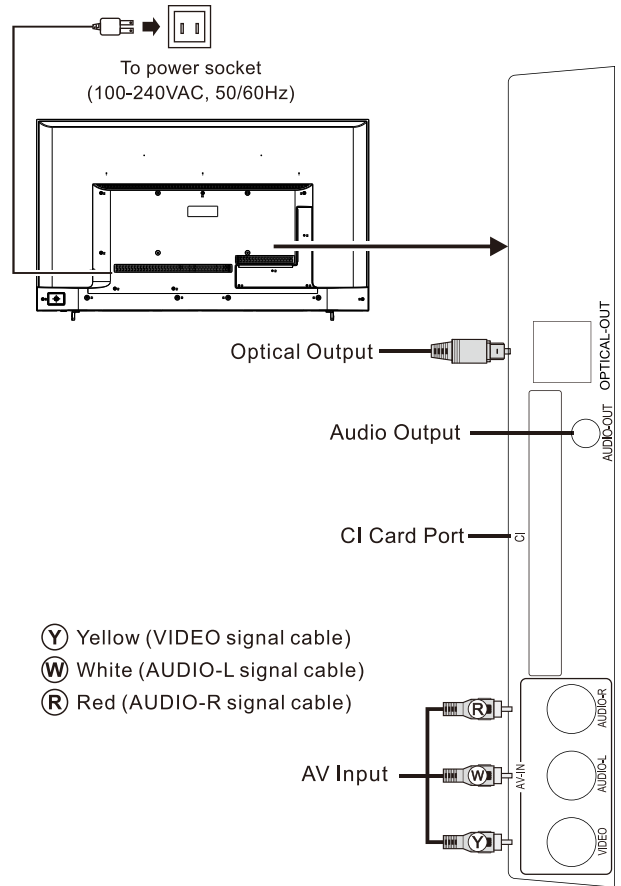
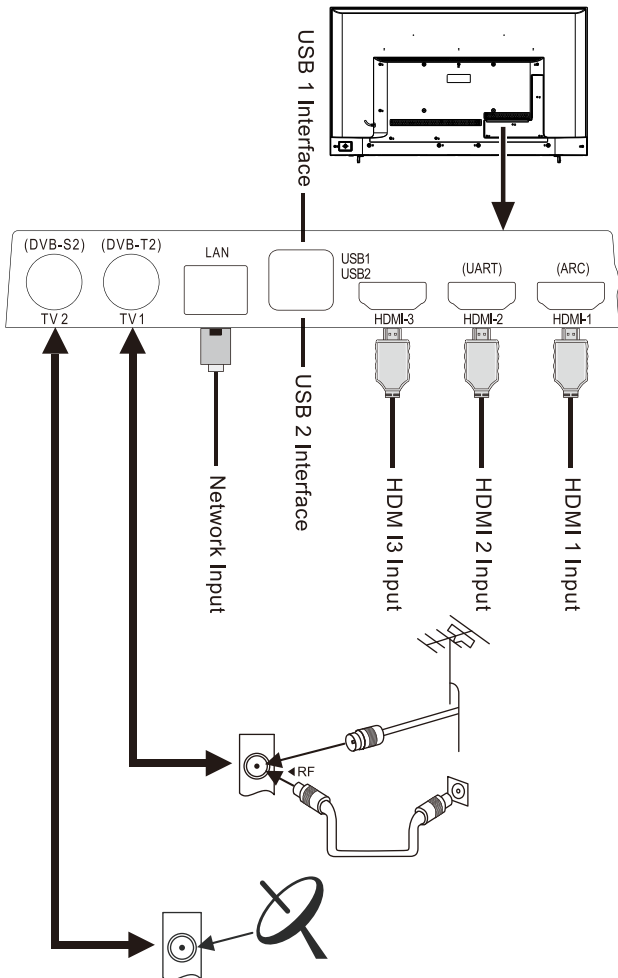

Warning

When connecting outdoor antenna to signal port of the TV set, please turn off the main power switch of the TV set first. Do not approach the outdoor antenna to high voltage mains power line to avoid electric shock. The wired network antenna connected to this TV set must be isolated from the protective grounding, or else it will cause fire or other hazards.

Panel Control Keys

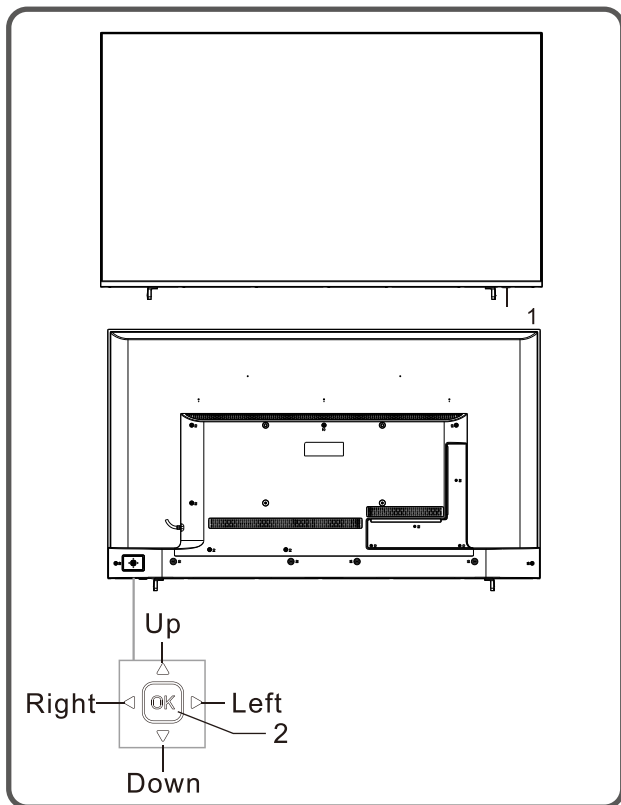

1. Power LED indicator and remote receiving window.
2. Rocker button combination key:

Power on or standby with **OK** rocker:



- ①. When Plugged power cord into the electrical socket, you can press **OK** rocker to turn on the TV.
- ②. In power on state, long press **OK** rocker 2 seconds to display the function menu, then move rocker Left/Right to select  and press **OK** rocker to switch to standby mode.



After turn on the TV, Press **OK** Rocker:

- ①. In non-OSD menu operation, long press **OK** rocker 2 seconds to display the function menu which includes 9 sorts. During the menu operation, press **OK** rocker to confirm the operation and the function is the same as [**OK**] key on the remote control.
- ②. In non-OSD menu operation, press **OK** key to display input source and the function is the same as [**SOURCE**] key on the remote control.



Move rocker **Left/Right**:

- ①. In non-OSD menu operation, move rocker

Left/Right to decrease/increase the volume, the function is the same as []/[] key on the remote control.

- ②. In OSD menu operation, move rocker **Left/Right** to adjust the analog value of selected item, the function is the same as []/[] key on the remote control.

Move rocker **Up/Down**:

- ①. In non-OSD menu operation, move rocker **Up/Down** to select the channel, the function is the same as [**P^**]/[**Pv**] key on the remote control.
- ②. In OSD menu operation, move rocker **Up/Down** to select the adjustment items, the function is the same as []/[] key on the remote control.

Remark:

- ①. The appearance varies depending on the model, and the actual product shall prevail.
- ②. In smart mode, please operate with the remote control.

Remote Control

Precautions for using the remote control

- The remote control should be pointed at the remote control sensor during operation. An object placed between the remote control and the remote control sensor may impede normal operation.
- The remote control should be prevented from strenuous vibration. Besides, please do not set or place the remote control under direct sunshine, as heating power may result in deformation of the remote control.
- Remote control failure may occur when the remote control sensor of the main unit is under direct sunshine or strong lighting; in this case, please change the angle of lighting or this TV set, or operate the remote control near the remote control sensor.
- Low battery will influence the remote control distance, in which case, the battery should be replaced with a new one. If the remote control is going to be idle for a long time or the battery runs out, please take the battery out to prevent the remote control from being corroded by battery leakage which may result in damage and failure of the remote control.
- Please do not use batteries of different types. It is not allowed to use old and new batteries together; the batteries should be replaced in pair.

- Please do not throw the batteries into fire or charge or decompose the batteries; do not charge, short-circuit, disassemble/assemble, heat or burn used batteries. Please dispose the waste batteries pursuant to relevant regulations on environmental protection.

Keys of the Remote Control

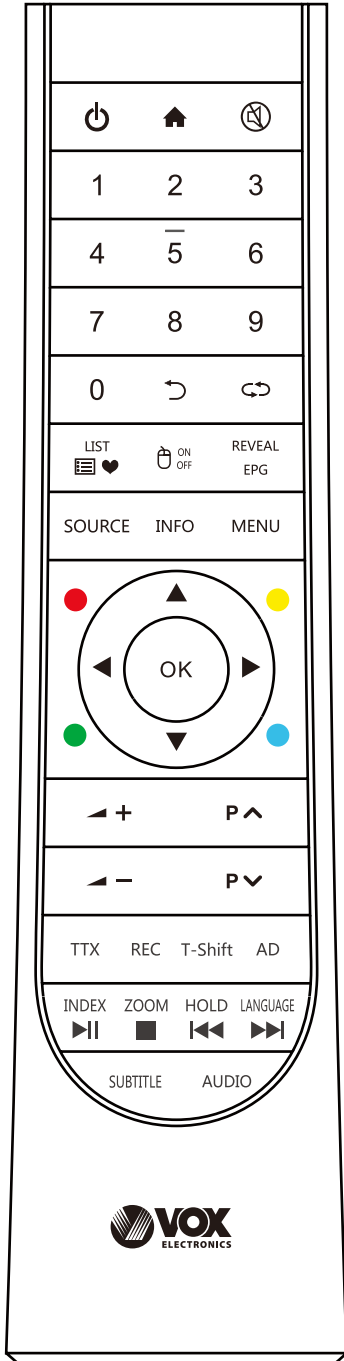

Note: The appearance of the remote control may be different from this diagram; please refer to the real object as standard.

Keys	Function
Power (⏻)	Switch between working and standby status.
Home (🏠)	Show the home page of smart TV.
MUTE (🔇)	Turn on/off the sound.
Number keys(0~9)	Enter numbers or select channel.
List (📺❤)	View program list.
↶↷	Return to last watching channel.
SOURCE	Select the signal source. (only in TV mode)
MENU	Show the OSD menu.
Cursor keys (▲, ▼, ◀, ▶)	Select items or adjust values.
OK	Confirm the operation.
VOL+/- (⏪ ⏩)	Turn up/down the volume.
Return(↶)	Return to previous page.
🖱 ON OFF	Turn on/off the mouse.
CH+/- (⏪ P ⏩)	Change program channel.
INFO	Show the information of the TV program.
SUBTITLE	Select subtitle language.
AUDIO	Select audio language.
AD	Turn on/off the associated audio.
TTX	Open teletext mode.
REC	Record programme.
T-Shift	Time shift in DTV mode.
REVEAL(EPG)	Displays the hidden text in teletext mode. (Electronic channel instructions.)
INDEX (▶)	Displays the index page in teletext mode. (Play/pause function in multimedia)
ZOOM (■)	Adjust the teletext size. (Stop function in multimedia)
HOLD (⏪)	Hold the displays at the current page. (Last file in multimedia).
LANGUAGE (▶▶)	Change teletext language. (Next file in multimedia).
Red key	Special function key.
Green key	
Yellow key	
Blue key	

Method for Installation of Remote Control Battery

Remove the battery compartment cover and insert two AAA (No. 7, 1.5V) batteries; make sure the polarity of the batteries is in compliance with the polarity mark "+" and "-" in the battery compartment of the remote control.

Basic Operations

Remark:

1. The keys operation refers to remote control operation, for panel control keys operation please refer to "**Panel Control Keys**" operation explanation.
2. Menu Operation Instruction in this manual is explained according to TV mode. The operations in other modes are similar to the one in TV mode, and users can take it as reference.
3. Before power-on platform, please make sure that the power supply is stable.

Turning on/Standby

Plug power cord into the electrical socket, then press [⏻] key to turn on the TV. The screen displays "Welcome" menu. Then you can set **Language**, **Net** and **Time** according to your needs. Finally, select **Finish** and press [OK] key to close the wizard.

In power on state, press [⏻] key to switch to standby mode.





★ **Special Tips:** This device adopts energy saving technology. If there is no signal input in power on state, it will enter standby state automatically in five minutes; The device will enter standby state automatically at specified sleep time.

Signal source selection

You can connect various devices to the TV set and view high quality images. If the video device has HDMI, AV and other video output ports. You can select one of them and connect to corresponding input ports of the TV set. After connected, turning on the device and press [SOURCE] key, then menu of signal source will be displayed on the screen. Press the [◀]/[▶] key to select the input signal, and press [OK] key to confirm .

Menu operation description

Press [MENU] key to show the main menu on the screen:

1. Press [▲]/[▼] key to select a menu from  (Picture),  (Sound),  (Channel),  (Setting),  (Parental Control). Then press [▶] key to enter the selected menu.
2. Press [▲]/[▼] key to select an item in the menu.
3. Press [OK] key to enter the submenu.
4. Press [◀]/[▶] key to adjust the value or setting.
5. When the main menu shows on the screen, press [MENU] key to exit the main menu; Press [↶] key to return to previous menu when the TV display the submenu.
6. During menu operation, the icons of invalid options will change into grey.

Note: The default password for the lock system is **0000**.

Program scanning

Tune the programs before watching the TV for the first time. Before scanning, please make sure that the antenna has been connected properly and select Antenna Type which want to choose. The following example channel searching **Antenna Type** is under **DVB-T**.

Auto Tuning

Press [MENU] key, and select  > **Auto Tuning**, then press [OK] key. Then you can select country where you are and press [OK] key to confirm(you need to enter the password when several country was chosen). The machine start auto tuning after selecting **Start Scan**. During auto tuning, you can select **Stop Scan** to exiting tuning.



DTV Manual Tuning







Press [MENU] key, Select  > **DTV Manual Tuning**, Press [OK] key to enter **DTV Manual Tuning** menu. Press [◀]/[▶] key to select channel, then press [▼] key to select **Start Scan** and press [OK] key to confirm.

ATV Manual Tuning

Press [MENU] key, Select  > **ATV Manual Tuning**, Press [OK] key to enter **ATV Manual Tuning** menu. Press [◀]/[▶] key to select frequency, then you can select **Scan Up** or **Scan Down** to tune for high frequency or low frequency. During the tuning, you can select **Stop Scan** to exiting tuning.

REC option









In DTV mode, Press [REC] key, REC option menu shows on the screen, and system begin recording right now. Press [■] key to stop and quit recording; Press [MENU] key and select  >  > **Record List**, then you can select the file you want to play, and press [OK] key to play it.

Icon	Description
	Play: Play.
	Stop: Stop and quit.
	Pause: Pause.
	FB: Fast back, press [▶] key to play normally.
	FF: Fast forward, press [▶] key to play normally.
	Forward: Make a 30S jump forward.
	Backward: Make a 30S jump backward.

Note: The recording function can only support memorizer with FAT32 file system. Memorizer with other file systems need to be formatted; Before formatting memorizer, back-up useful data because the content of memorizer can not recover after formatting.

Time Shift option





In DTV mode, Press [T-Shift] key, Time Shift option menu shows on the screen and the program is in suspended state. Press [▶||] key to resume play program. Press [■] key to stop and quit time-shift. When user leaves program for a short time, time-shift function can suspend and cache the playing program to U disk. When user resumes playing, the program can continue to be played.

Icon	Description
	Play: Play.
	Stop: Stop and quit.
	Pause: Pause.
	FB: Fast back, press [▶] key to play normally.
	FF: Fast forward, press [▶] key to play normally.
	Forward: Make a 30S jump forward.
	Backward: Make a 30S jump backward.
	Time Play: Select time to play.

Instructions for Intelligent Platform Operation

Basic Operations

Press [] key to show the home page.

1. Press []/[]/[]/[] key to select an application;
2. Press [OK] key to run the application;
3. Press [] key to return to previous page;

★ Special Tips

The operations in smart mode are complicated. The user can install Apps with different operation methods, and the operations described in this manual are for reference only. Part of applications need external equipment to run normally. Certain functions are invalid from the remote control. For more convenient operation, please operate with USB mouse and keyboard.



Quick Start



Before using this device, please get familiar with the operations below for better experience.

Mouse Control

1. Click: Click the mouse and release immediately;
2. Press and hold: Click the mouse and hold for at least three seconds;
3. Clicking the left mouse key has the same effect as pressing [OK] key on the remote control;
4. Clicking the right mouse key has the same effect as pressing [] key on the remote control.

Language input setting

Language: In the smart mode, select the system language. Select **Setting > Language**, and press [OK] key. Press []/[] key to select the desired language, and then press [OK] key.

Selecting Input Method: In the smart mode, select **Setting > All Settings > Universal > Input Method**, and press []/[] key to choose input method ; you can also download and install third party input method.

Setting System Time: In the smart mode, select **Setting > Time > Automatic Date&time**, then the network-provided time will be used by set it as **Network**. You can also set the system time manually.

Smart Applications

Browser: You can use the browser to show the text, video, audio and other information on the Internet.

Before accessing the Internet, please connect your TV set to the Internet; refer to “**Network Settings**” for details.

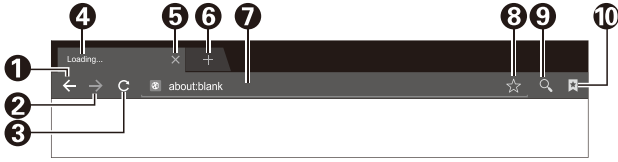

①	Back to the previous webpage.
②	Go forward to the next webpage.
③	Refresh the webpage.
④	Webpage window of the browser.
⑤	Close the current webpage window.
⑥	Add a new webpage window.
⑦	Input box for URL.
⑧	Option for adding a bookmark.
⑨	Input option of URL.
⑩	Option for viewing bookmark.

Note: Press [MENU] key to display the menu option of browser.

■ How to access web address?

Press [▲]/[▼]/[◀]/[▶] key to select the address bar, and type the web address in the address bar, then select the → icon in the input method, and press [OK] key to access the web address.

■ How to save a page in the Bookmark?

Select the ☆ icon the browser interface, and press [OK] key to enter the browser tab and web address. Select **Account**, and press [OK] key. Press [▲]/[▼] key to select the account for storage, and then press [OK] key. Select **OK**, and then press [OK] key to add the bookmark.

■ How to copy and paste the text in the web page?

Place the cursor on the text to copied, then press and hold the left mouse key. When the pair of selecting cursors appears on the screen, drag the cursor to select the text. Select **Copy** on the screen, and click the left mouse key. Select the target position, press and hold the left mouse key, and click **Paste** in the popup dialog box.

Apk Installer: The **Apk installer** helps users manage applications, and allows users to install or uninstall apps in local disk.

■ How to install an application?

Select **My Apps > All Apps > FileManager** and press [OK] key to enter, then press [▲]/[▼]/[◀]/[▶] key to select **Apk** and press [OK] key to enter. Select the target installation file in local disk, and press [OK] key to install. Then select **INSTALL** and press [OK] key. Several Apk need setting security when you install it.

■ How to uninstall an application?

Select **My Apps > Smart Assistant > App Manager**. Select the application which you want to uninstall and press [OK] key, then select **Uninstall** and press [OK] key to uninstall the application.

Multimedia Player: In smart mode, select **Multimedia** in the main interface, and press [OK] key to run. Select the file type from **All, Video, Music and Picture**.

■ Playing Files in local disk device: Before playing files in the local disk, insert the USB mass storage device into the USB interface.

Select local disk device in the file directory, and press [OK] key to enter. Select the target folder or file, press [OK] key to enter the folder or play the file, and press [↵] key to return to the desktop.

Attention:



1. Unstandard USB devices can't be recognized probably; in this case, please replace a standard USB device;
2. The stream media system has certain restriction on the format of files; the playing will be abnormal if it is out of the system restriction;
3. Do not remove the USB device while playing, or else the system or device may have problem; Before replace the USB device, please turn off the machine's power supply;
4. The system supports standard USB1.1 and USB2.0 devices, such as USB mass storage devices and removable hard disks;
5. The maximum output current of the USB port of this device is 500mA, and the self-protection will be enabled if it is beyond this limit; please use external power supply if an external device of higher current will be connected;
6. The system is complicated; when it is reading or playing files, the screen may be still or certain functions may be invalid due to the compatibility

and stability of the USB device; in this case, please turn off the device and re-initialize the system.

Press [OK] key can display or hide toolbar, While playing, select the menu option which you want, and press [OK] key to perform the operation; you can press [↵] key to exit playing, or press [▶▶]/[■]/[◀◀]/[▶▶] key on the remote control to perform shortcut operation.

Network Settings

Wi-Fi

1. In smart mode, select **Setting > Network > Wi-Fi**. Press [OK] key, then press [◀]/[▶] key to select **On** or **Off** and the machine automatically search for nearby wireless network signal when selecting **On**. The network searched with  icon indicate that the machine connects to the network without a password. The network with  icon indicate that it is encrypted and you must enter the correct password to connect to the network.
2. Select the network which you want to select in the network list, and press [OK] key;
3. Type network connecting password in the Password box, then select **Connect** and press [OK] key to connect to network;

Ethernet

1. Select **Setting > Network > Ethernet** and press [OK] key;
2. Set **Auto Connect** as **On**, and your machine will obtain an IP address automatically;
3. If your devices does not support automatically obtain an IP address, you need set **Auto Connect** as Off. Then select **IP Setting** and press [OK] key to enter;
4. Enter the IP Address, Subnet Mask, Gateway, and DNS1, DNS2;
5. Select **OK** and press [OK] key to connect to the network.

Portable Hotspot

1. Select **Setting > Network > Portable Hotspot** and press [OK] key;
2. Select **Hotspot Settings** and set it as **On**;
3. Enter the hotspot name in the network name field;
4. In the security field, press [◀]/[▶] key to select security type. When the security type was

selected as **None**, anyone who search out your network does not need a password to connect to the network. If you select **WPA2 PSK** encryption, you need to enter a password more than eight characters. Anyone who search out your shared Wi-Fi network need to enter the correct password to connect to your network;

5. You can type a password in the password frame for yourself;
6. Select **Save** and press [OK] key to save the settings, then other Wi-Fi devices in search for Wi-Fi networks will search your network in the area.

Hotel Function(optional)

Press "MENU" key on the remote control to display the main TV menu, and then press "4578" on the remote control to display the hotel function menu. Press "▲/▼" key to enter into the menu and select the item which you need to adjust, and then press "◀/▶" key to adjust the value or state.

Important Statement on Network Services

All contents and services obtained from this TV set belong to the third party and are protected by laws on copyright, patent right, trademark right and/or other intellectual property right. The said contents and services are only for your non-commercial purposes. It is not allowed to use any content or service without the authorization of the content owner or the service provider.

Our company will undertake no liability for any direct, indirect and accidental losses or damages caused by your or a third party's access to any content or service or any information or any third party software through this set under any circumstances.

Third party service may be changed, deleted or stopped without prior notice. Our company neither implies nor guarantees the continuous availability of some service or content within any period of time.

Our company is not held responsible for services related to the said service and content. Besides, we will not bear any liability for client service. Please directly contact relevant content and service providers if you have any problem and service request concerning relevant service or content.

Troubleshooting

- **Snowflake spots occur in the TV images and there is noise in accompanying sound.**
 1. Check if the antenna plug is loose or the cable is in good condition.
 2. Check the antenna type (VHF/UHF).
 3. Adjust the direction and position of the antenna.
 4. Try to use signal enhancer.
- **There is neither display nor sound on the screen. The indication light is not on.**

Check if the power line is connected.
- **Dotted line or strip disturbance occurs in TV images.**

Do not use electric hair dryer aside the TV set and adjust the antenna direction to reduce disturbance.
- **Double images occur on the TV screen.**
 1. Use high oriented antenna.
 2. Adjust the direction of the antenna.
- **The images are colorless.**

Enter "[📺]" setting to increase color saturation.
- **The TV has no accompanying sound.**
 1. Adjust the volume to a proper degree.
 2. Press [🔇] key on the remote control to cancel mute mode.
- **No signal input images show on the machine screen. The indicator light is blinking.**
 1. Check if the signal connecting cable is loose or falls off. Reconnect it.
 2. The machine may be in standby mode, please reboot.
- **The remote control distance is short or out of control.**
 1. Remove the object to avoid blocking the remote control receiving window.
 2. Replace the battery.
- **The browser cannot access any link.**
 1. Ask the network administrator to obtain available IP address and other parameters.
 2. Check if the network connecting cable is normally connected.
 3. Consult the network service provider.
- **Online video play is very slow.**
 1. Please upgrade your network bandwidth to a higher one.
 2. Please try to replace with other addresses to obtain better resources.

- **Machine is slow, system crash, can't operate the machine.**

Disconnect the power supply first, and connect the power supply after about 1-2 minutes, then turn on the TV again.

Technical Specifications

Master unit

Max. Resolution	3840×2160
Power Supply	100V-240VAC 50/60Hz
Power Consumption of Speaker	8W+8W
Operating environment:	
Temperature	5°C~40°C
RH	10%~85%
Atmospheric pressure	86kPa~106kPa
Storage environment:	
Temperature	-20°C~55°C
RH	5%~95%
Atmospheric pressure	86kPa~106kPa

Dimension (L×W×H) and Weight

50"

Excluding base	Unpacking: 1112×70×642(mm ³)
Including base	Unpacking: 1112×243×672(mm ³) Packing: 1218×120×734(mm ³) Net Weight: 10kg Gross Weight: 12.1kg

Technical specifications for TV

- Supported standard:
ATV: PAL D/K, I, B/G, SECAM D/K, B/G;
DTV: DVB-T/T2/C(DVB-S/S2 option).
- Antenna input: 75Ω coax, unbalanced.
- AV video input: 75Ω, 1±0.1Vp-p, RCA terminal.
- AV audio input: 20KΩ, 0.2~2Vrms.
- HDMI video input: 480i, 480P, 576i, 576P, 720P, 1080i, 1080P, 2160P.
- Specific internal memory capacity in accordance with actual configuration.
- Specific cache capacity in accordance with actual configuration.
- Wireless connection: Wi-Fi (IEEE 802.11 b/g/n).
- Intelligent operating system: Android.

Power management

Mode	Power Consumption
	50"
Normal working	≤130W
Standby	≤0.5W

HDMI display mode

Video mode			
NO.	Mode	Resolution	Refresh rate
1	SD	720×480i/p	60Hz
2		720×576i/p	50Hz
3	HD	1280×720p	50Hz
4			60Hz
5	FHD	1920×1080i/p	50Hz
6			60Hz
7	UHD	3840×2160p	24Hz
8			25Hz
9			30Hz
10			50Hz
11			60Hz

Remark: Under UHD mode, 50Hz and 60Hz refresh rate is effective only under HDMI version 2.0.

VESA mode			
NO.	Mode	Resolution	Refresh rate
1	VGA	640×480	60Hz
2	SVGA	800×600	60Hz
3	XGA	1024×768	60Hz
4	SXGA	1280×1024	60Hz
5	WXGA	1600×900	60Hz
6	WUXGA	1920×1080	60Hz
7	4K	3840×2160	30Hz
8			60Hz

Remark: Under 4K mode, 60Hz refresh rate is effective only under HDMI version 2.0.

Use of a TV wall mounting

Warning

- Please purchase a suitable TV wall mount when mounting your TV on the wall.
- Ensure that the bearing capacity of the wall for mount installation is no less than 4 times the weight of the TV set and the wall mount so as to avoid falling.
- Please refer to the instructions provided with the TV set and wall mount for installation.
- Make sure there is no cable or conduit in the wall section where a wall mount will be installed.
- Please entrust a professional technician to complete installation. The company shall not be liable for accidents, personal injury or damage caused by improper installation of TV set.

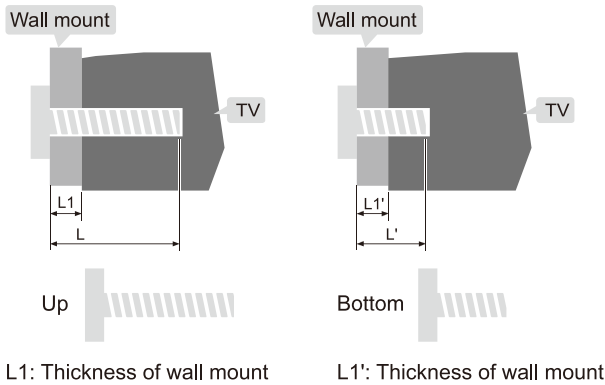
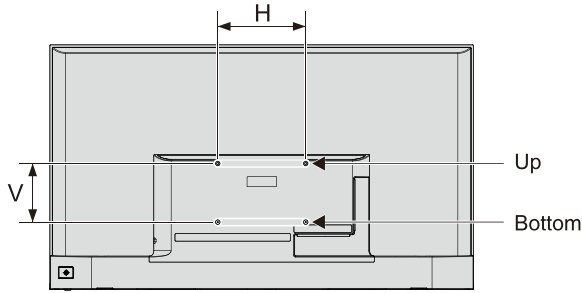

Distance between holes on the wall(H×V)(mm)	Required screws (recommended bolt length)(mm)
50": 300 x 200	Up: 2 x M6 (28+L1≤L≤30+L1), Machine screws Bottom: 2 x ST6 (6+L1'≤L'≤9.5+L1'), Flat tail self-tapping screws

Note:

- If any screws are found in the screw hole for wall mount behind the TV set before installing the wall mount, the screws shall be removed and put in place for later use.
- Please buy the wall screws according to the actual situation.
- If there are flat tail self-tapping screws in the accessories, please decide whether it is suitable for use according to the actual situation of the wall mount.

ST6x8 flat tail self-tapping screws 2pcs(option)

Base Installation Instructions

Put the machine flat first, distinguish left and right base and base installation front and back direction, then install the bases in the bottom of the machine back cover as arrow direction in figure. Align screw holes, then fasten screws (notice that base module has to be adjusted at figure status, otherwise it cannot be installed in.)

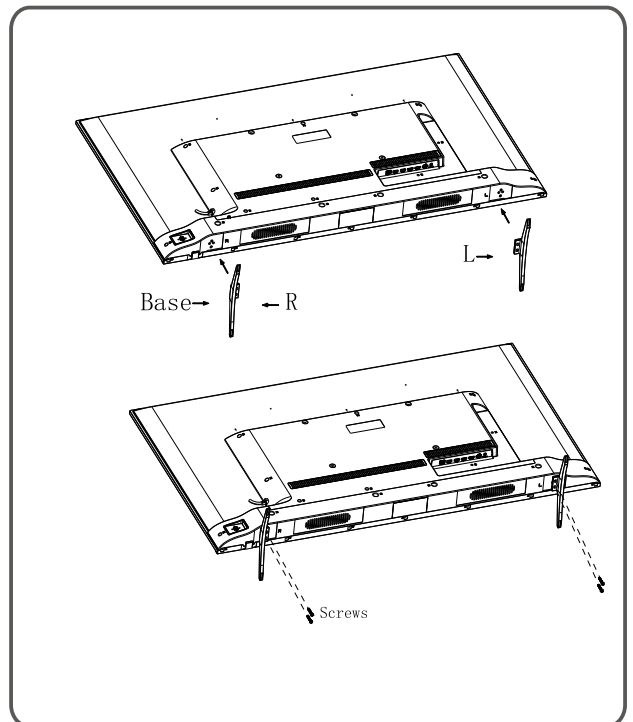

Remark: The actual base and machine appearance may be different from pictures; please refer to the actual device.

