



ENG





EBI444

ENG Hob / User Manual

Thank you for choosing this product.

This User Manual contains important safety information and instructions on the operation and maintenance of your appliance.

Please take the time to read this User Manual before using your appliance and keep this book for future reference.

Icon	Type	Meaning
	WARNING	Serious injury or death risk
	RISK OF ELECTRIC SHOCK	Dangerous voltage risk
	FIRE	Warning; Risk of fire / flammable materials
	CAUTION	Injury or property damage risk
	IMPORTANT / NOTE	Operating the system correctly

CONTENTS

1.SAFETY INSTRUCTIONS.....	4
1.1 General Safety Warnings	4
1.2 Installation Warnings	6
1.3 During Use	7
1.4 During Cleaning and Maintenance	8
2.INSTALLATION AND PREPARATION FOR USE.....	10
2.1 Instructions for the Installer	10
2.2 Installation of the Hob.....	10
2.3 Electrical Connection and Safety.....	12
3.PRODUCT FEATURES	13
4.USE OF PRODUCT	14
4.1 Hob controls	14
5.CLEANING AND MAINTENANCE.....	17
5.1 Cleaning	17
6.TROUBLESHOOTING&TRANSPORT	18
6.1 Troubleshooting.....	18
6.2 Transport	18
7.TECHNICAL SPECIFICATIONS.....	19
7.1. Energy Fiche	19



1. SAFETY INSTRUCTIONS

- Carefully read all instructions before using your appliance and keep them in a convenient place for reference when necessary.
- This manual has been prepared for more than one model therefore your appliance may not have some of the features described within. For this reason, it is important to pay particular attention to any figures whilst reading the operating manual.

1.1 General safety warnings

- This appliance can be used by children aged from 8 years and above and by persons with reduced physical, sensory or mental capabilities or lack of experience and knowledge if they have been given supervision or instruction concerning use of the appliance in a safe way and understand the hazards involved. Children should not play with the appliance. Cleaning and user maintenance should not be made by children without supervision.

 **WARNING:** The appliance and its accessible parts become hot during use. Care should be taken to avoid touching heating elements. Keep children less than 8 years of age away unless they are continually supervised.

  **WARNING:** Unattended cooking on a hob with fat or oil can be dangerous and may result in fire. NEVER try to extinguish such a fire with water, but switch off the appliance and cover the flame with a lid or a fire blanket.

 **CAUTION:** The cooking process has to be supervised. A short term cooking process has to be supervised continuously

 **! WARNING:** Danger of fire: Do not store items on the cooking surfaces.

 **! WARNING:** If the surface is cracked, switch off the appliance to avoid the possibility of electric shock.

- For induction hobs, metallic objects such as knives, forks, spoons and lids should not be placed on the hob surface because they can get hot.
- For induction hobs, after use switch off the hob element using the control knob. Do not rely on the pan detector.
- For models which incorporate a hob lid, clean any spillages off the lid before use and allow the cooker to cool before closing the lid.
- Do not operate the appliance with an external timer or separate remote-control system.
- Do not use harsh abrasive cleaners or scourers to clean oven surfaces. They can scratch the surfaces which may result in shattering of the door glass or damage to surfaces.
- Do not use steam cleaners for cleaning the appliance.
- Your appliance is produced in accordance with all applicable local and international standards and regulations.
- Maintenance and repair work should only be carried out by authorised service technicians. Installation and repair work that is carried out by unauthorised technicians may be dangerous. Do not alter or modify the specifications of the appliance in any way. Inappropriate hob guards can cause accidents.
- Before connecting your appliance, make sure that the local distribution conditions (nature of the gas and gas pressure or electricity voltage and

frequency) and the specifications of the appliance are compatible. The specifications for this appliance are stated on the label.

 **CAUTION:** This appliance is designed only for cooking food and is intended for indoor domestic household use only. It should not be used for any other purpose or in any other application, such as for non-domestic use, in a commercial environment or for heating a room.

- All possible measures have been taken to ensure your safety. Since the glass may break, care should be taken while cleaning to avoid scratching. Avoid hitting or knocking the glass with accessories.
- Make sure that the supply cord is not trapped or damaged during installation. If the supply cord is damaged, it must be replaced by the manufacturer, its service agent or similarly qualified persons in order to prevent a hazard.
- Please keep children and animals away from this appliance.
- When the induction hob is in use, keep the objects that are sensitive to magnetic fields (such as credit cards, bank cards, watches, and similar items) away from the hob. It is strongly suggested that anyone with a pacemaker should consult their cardiologist before using the induction hob.

1.2 installation warnings

- Do not operate the appliance before it is fully installed.
- The appliance must be installed by an authorised technician. The manufacturer is not responsible for any damage that might be caused by defective placement and installation by unauthorised people.

- When the appliance is unpacked, make sure that it has not been damaged during transportation. In the case of a defect do not use the appliance and contact a qualified service agent immediately. The materials used for packaging (nylon, staplers, Styrofoam, etc.) may be harmful to children and they should be collected and removed immediately.
- Protect your appliance against atmospheric effects. Do not expose it to effects such as sun, rain, snow, dust or excessive humidity.
- Materials around the appliance (i.e. cabinets) must be able to withstand a minimum temperature of 100°C.
- The temperature of the bottom surface of the hob may rise during operation, therefore a board must be installed underneath the product.

1.3 During use

- Do not put flammable or combustible materials in or near the appliance when it is operating.



Do not leave the cooker unattended while cooking with solid or liquid oils. They may catch fire under extreme heating conditions. Never pour water on to flames that are caused by oil, instead switch the cooker off and cover the pan with its lid or a fire blanket.

- If the product will not be used for a long period of time, turn the main control switch off. Turn the gas valve off when a gas appliance is not in use.
- Always position pans over the centre of the cooking zone, and turn the handles to a safe position so they cannot be knocked or grabbed.
- Make sure the appliance control knobs are always in the “0” (stop) position when it is not in use.

1.4 During cleaning and maintenance

- Make sure that your appliance is turned off at the mains before carrying out any cleaning or maintenance operations.
- Do not remove the control knobs to clean the control panel.
- To maintain the efficiency and safety of your appliance, we recommend you always use original spare parts and to call our authorised service agents in case of need.

CE Declaration of conformity

 We declare that our products meet the applicable European Directives, Decisions and Regulations and the requirements listed in the standards referenced.

This appliance has been designed to be used only for home cooking. Any other use (such as heating a room) is improper and dangerous.

 The operating instructions apply to several models. You may notice differences between these instructions and your model.

Disposal of your old machine



This symbol on the product or on its packaging indicates that this product should not be treated as household waste. Instead it should be handed over to the applicable collection point for the recycling of electrical and electronic equipment. By ensuring this product is disposed of correctly, you will help prevent potential negative consequences for the environment and human health, which could otherwise be caused by inappropriate waste handling of this product. For more detailed information about recycling of this product,

please contact your local city office, your household waste disposal service or the retailer who you purchased this product from.

2. INSTALLATION AND PREPARATION FOR USE

WARNING: This appliance must be installed by an authorised service person or qualified technician, according to the instructions in this guide and in compliance with the current local regulations.

- Incorrect installation may cause harm and damage, for which the manufacturer accepts no responsibility and the warranty will not be valid.
- Prior to installation, ensure that the local distribution conditions (electricity voltage and frequency and/or nature of the gas and gas pressure) and the adjustments of the appliance are compatible. The adjustment conditions for this appliance are stated on the label.
- The laws, ordinances, directives and standards in force in the country of use are to be followed (safety regulations, proper recycling in accordance with the regulations, etc.).

2.1 instructions for the installer

General instructions

- After removing the packaging material from the appliance and its accessories, ensure that the appliance is not damaged. If you suspect any damage, do not use it and contact an authorised service person or qualified technician immediately.
- Make sure that there are no flammable or combustible materials in the close vicinity, such as curtains, oil, cloth etc. which may catch fire.
- The worktop and furniture surrounding the appliance must be made of materials resistant to temperatures above 100°C.
- If a cooker hood or cupboard is to be installed above the appliance, the safety distance between cooktop and any cupboard/cooker hood should be as shown below.

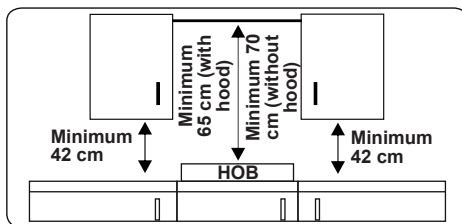

- The appliance should not be installed directly above a dishwasher, fridge, freezer, washing machine or clothes dryer.
- If the base of the appliance is accessible by hand, a barrier made from a suitable material must be fitted below the base of the appliance, ensuring that there is no access to the base of the appliance.
- If the hob is installed above an oven, the oven should have a cooling fan.
- Make sure that the induction hob is well ventilated and the air inlet and outlet are not blocked.

2.2 installation of the hob

The appliance is supplied with an installation kit including adhesive sealing material, fixing brackets and screws.

- Cut the aperture dimensions as indicated in the figure. Locate the aperture on the worktop so that, after the hob is installed, the following requirements are followed.

B (mm)	590	min. A (mm)	50
T (mm)	520	min. C (mm)	50
H (mm)	56	min. E (mm)	500
C1 (mm)	560	min. F (mm)	10
C2 (mm)	490	G (mm)	20
D (mm)	50	I (mm)	38
J (mm)	5		

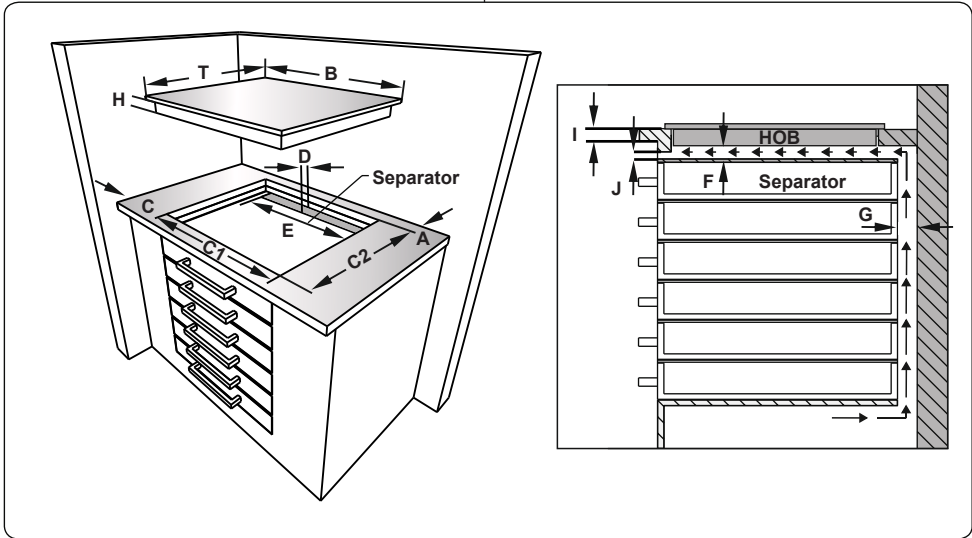
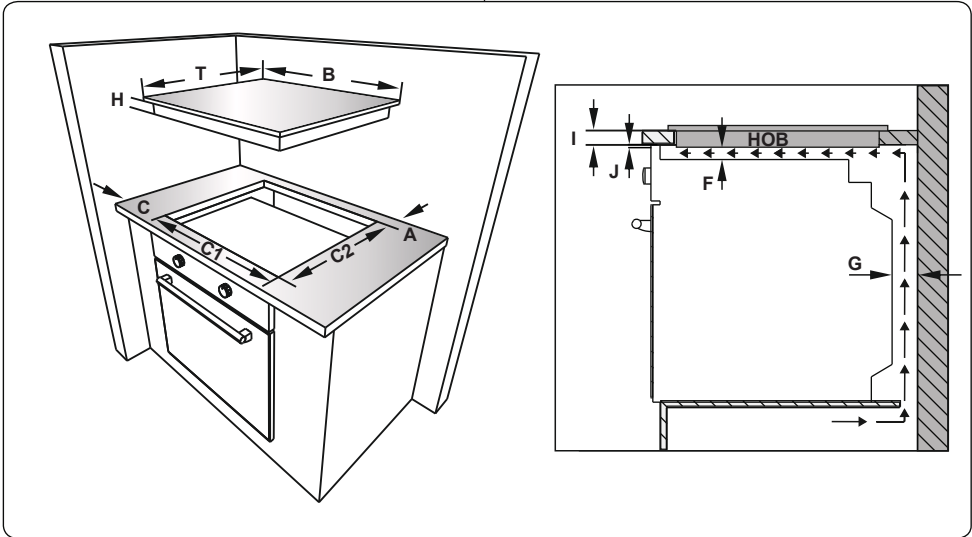

- Apply the supplied one-sided self-adhesive sealing tape all the way around the lower edge of the cooktop. Do not stretch it.

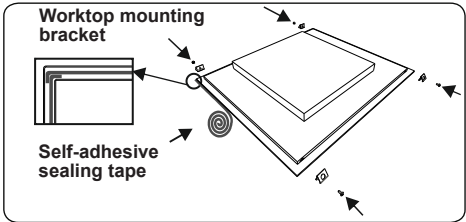

- Screw the 4 worktop mounting brackets in to the side walls of product.

- Insert the appliance into the aperture.

2.3 electrical connection and safety

⚠ WARNING: The electrical connection of this appliance should be carried out by an authorised service person or qualified electrician, according to the instructions in this guide and in compliance with the current local regulations.

⚠ WARNING: THE APPLIANCE MUST BE EARTHED.

- Before connecting the appliance to the power supply, the voltage rating of the appliance (stamped on the appliance identification plate) must be checked for correspondence to the available mains supply voltage, and the mains electric wiring should be capable of handling the appliance's power rating (also indicated on the identification plate).
- During installation, please ensure that isolated cables are used. An incorrect connection could damage your appliance. If the mains cable is damaged and needs to be replaced this should be done by a qualified person.
- Do not use adaptors, multiple sockets and/or extension leads.
- The supply cord should be kept away from hot parts of the appliance and must not be bent or compressed. Otherwise the cord may be damaged, causing a short circuit.
- If the appliance is not connected to the mains with a plug, a all-pole disconnecter switch (with at least 3 mm contact spacing) must be used in order to meet the safety regulations.
- The fused switch must be easily accessible once the appliance has been installed.
- Ensure all connections are adequately tightened.
- Fix the supply cable in the cable clamp and then close the cover.
- The terminal box connection is placed on the terminal box.

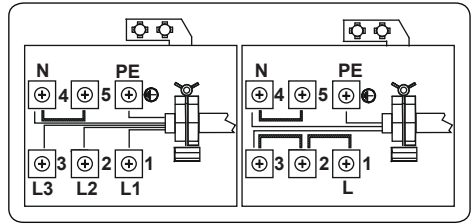

3. PRODUCT FEATURES



Important: Specifications for the product vary and the appearance of your appliance may differ from that shown in the figures below.

List of Components

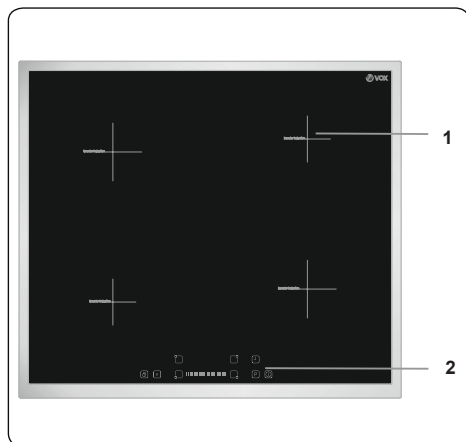

1. Induction zone

2. Control Panel

4. USE OF PRODUCT

4.1 hob Controls

Induction Zone

The information given in the following table is for guidance only.

Settings	Use for
0	Element off
1-3	Delicate warming
4-5	Gentle simmering, slow warming
6-7	Reheating and rapid simmering
8	Boiling, saute and searing
9	Maximum heat
P	Boost function

Cookware

- Use thick, flat, smooth bottomed good quality cookware made of steel, enamelled steel, cast iron or stainless steel. The quality and composition of the cookware has a direct affect on cooking performance.
- Cookware with enamelled steel, aluminium or copper bottoms can cause a metallic residue to remain on the hob. If left, this becomes difficult to remove. Clean the hob after every use.
- Cookware is suitable for induction cooking if a magnet sticks to the bottom of it.
- Cookware must be placed centrally on the cooktop. If it is not placed correctly, is displayed.
- When using certain pans, you may hear various noises coming from them, this is due to the design of the pans and does not effect the performance or safety of the hob.
- The minimum cookware diameter that the elements can detect is Q110mm for 160mm - 210mm hobs and Q160mm for a 290mm hob. Cooking performance is improved with a larger cooking area.

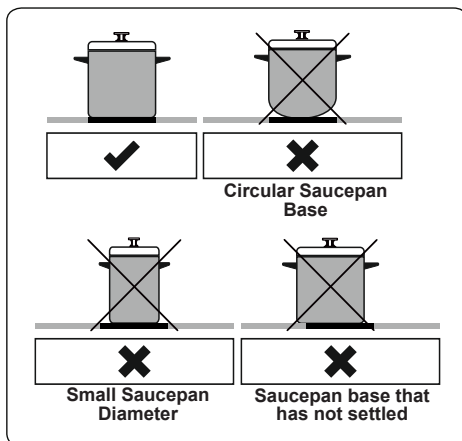

The appliance is operated by pressing buttons and the functions are confirmed by displays and audible sounds.

Touch Control Unit

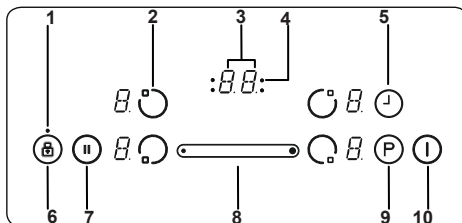

- 1- Key Lock indicator
- 2- Heater selection
- 3- Timer display
- 4- Timer function cooking zone indicators
- 5- Timer selection
- 6- Key Lock
- 7- Smart Pause
- 8- Slider button
- 9- Boost
- 10- On/Off

Use the induction cooking zones with suitable cookware.

After mains voltage is applied, all displays are illuminated briefly. After this, the hob is in stand-by mode and ready for operation.

The hob is controlled by pressing the appropriate electronic button. Each button pressed is followed by a buzzer sound.

Switching the Appliance On

Switch the hob on by pressing the ON/OFF button (10). All heater displays will show a

static "0" and the bottom right dots blink. (If a cooking zone is not selected within 20 seconds, the hob will automatically switch off).

Switching the Appliance Off

Switch the hob off at any time by pressing .

The ON/OFF button  always has priority over the switch-off function.

Switching the Cooking Zones On

Press the heater selection button that corresponds to the heater you wish to use. A static dot will be shown on the selected heater display and the blinking dots on all other heater displays will no longer illuminate.

For the selected heater, you can set the heat level by pressing the Sliding Button . The element is now ready to use. For fast boil times, select the desired cooking level, then press the "P" button to activate the Boost function.

Switching the Cooking Zones Off

Select the element you want to switch off by pressing the heater selection key. Using the Sliding Button , turn the temperature down to "0". (Pressing the right and left of the slider button simultaneously also turns the temperature to "0").

If the cooking zone is hot, "H" will be displayed instead of "0".

Switching all Cooking Zones Off

To switch all the cooking zones off at once, press the  key.

In stand-by mode, a "H" will appear on all cooking zones which are hot.

Residual Heat Indicator

The residual heat indicator indicates that the glass ceramic area has a temperature that is dangerous to touch.

After switching off the cooking zone, the respective display will show "H" until the corresponding cooking zone temperature is at a safe level.

Smart Pause

Smart Pause, when activated, reduces the power of all burners that have been switched on.

If you then deactivate the Smart Pause, the heaters will automatically return to the previous temperature level.

If the Smart Pause is not de-activated, the cooktop will switch off after 30 minutes.

Press  to activate Smart Pause. The power for the activated heater(s) will reduce to level 1 and "II" will appear at all displays.

Press  again to deactivate Smart Pause. "II" will disappear and the heaters will now run at the level previously set.

Safety Switch-Off Function

A cooking zone will automatically switch off if the heat setting has not been modified for a specified duration of time. A change in the heat setting of the cooking zone will reset the time duration to the initial value. This initial value depends on the selected temperature level, as shown below.

Heat setting	Safety switch off after
1-2	6 Hours
3-4	5 Hours
5	4 Hours
6-9	1.5 Hours

Child Lock

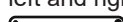
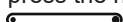
After switching on the appliance, the child lock function can be activated. To activate the child lock, simultaneously press the left and right side of the Sliding Button  and then press the right side of the Sliding Button  again. "L" indicating LOCKED will appear on all heater displays and the controls can not be used. (If a cooking zone is in the hot condition, "L" and "H" will display alternately).

The hob will remain in a locked condition until it is unlocked, even if the appliance has been switched off and on.

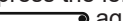
To deactivate the child lock, first switch on the hob. Simultaneously press the left and right side of the Sliding Button  and then press the left side of the Sliding Button  again. "L" will no longer be displayed and the hob will switch off.

Key Lock

The key lock function is used to set 'safe mode' on the appliance during operation. It will not be possible to make any adjustments by pressing the buttons (for example heat settings). It will only be possible to switch the appliance off.



The lock function is active if the key lock button  is pressed for at least 2 seconds. This operation is acknowledged by a buzzer. After successful operation, the key lock indicator will flash and the heater will be locked.

Timer Function



The timer function is available in two versions, as follow.

Minute Minder Timer (1 - 99 min.)

The minute minder timer can be operated if the cooking zones are switched off. The timer display will show "00" with a blinking dot.

Use the Timer  and Sliding Button  to increase/decrease the time. The range is between 0 and 99 minutes. If there is no adjustment to the displayed time within 10 seconds, the minute minder timer will be set and the blinking dot will disappear. Once the timer is set, it begins to count down.

When the timer reaches zero, a signal will sound and the timer display will blink. The sound signal will stop automatically after 2 minutes and/or by pressing any button.

The minute minder timer can be changed or switched off any time by using the Timer  and Sliding Button . Switching off the hob by pressing  at any time will also switch off the minute minder timer.

Cooking Zone Timer (1 - 99 min.)

When the hob is switched on, an independent timer can be programmed for each cooking zone.

Select a cooking zone, then select the temperature setting and, finally, activate the timer setting button , the timer can be programmed to switch off a cooking zone. Four LEDs are arranged around the timer that indicate which cooking zone the timer has been set for.

10 seconds after the last operation, the timer display will change to the timer that will run out next (in cases where a timer is set for more than one cooking zone).

When the timer has run down, a signal will sound, the timer display will show "00" and the assigned cooking zone timer LED will blink. The programmed cooking zone will switch off and "H" will be displayed if the cooking zone is hot.

The sound signal and the blinking of the timer LED will stop automatically after 2 minutes and/or by pressing any button.

Buzzer

While the hob is in operation, the following activities will be signalled by the buzzer.

- Normal button activation will be accompanied with a short sound signal.

- Continuous button operation over a longer period of time (10 seconds) will be accompanied with a longer, intermittent sound signal.







Boost Function

To use this function, select a cooking zone and set the desired cooking level, then press the "P" (Boost) button.

The Boost function can only be activated if it is applicable with the cooking zone selected. If the Boost Function is active, a "P" will be shown on the corresponding display.

Activating the booster can exceed the maximum power, in which case the integrated power management will be activated.

The necessary power reduction is shown by the corresponding cooking zone display blinking. Blinking will be active for 3 seconds to allow for further adaptations of the settings before power reduction.

Error Codes	
If there is an error, an error code will be shown on the heater displays.	
E1	Cooling Fan is disabled. Call an authorised service agent.
E3	Supply voltage is other than the rated values. Switch the hob off by pressing  , wait until "H" disappears for all zones, switch the hob on by pressing  and continue to use. If the same error is displayed again, call an authorised service agent.
E4	Supply frequency is different from the rated values. Switch the hob off by pressing  , wait until "H" disappears from all zones, switch the hob on by pressing  and continue to use. If the same error is displayed again, switch the plug for the appliance off and on. Switch the hob on by pressing  and continue to use. If the same error is displayed again, call an authorised service agent.
E5	Internal temperature of the hob is too high, switch the hob off by pressing  and let the heaters cool down.
E6	Communication error between the touch control and heater. Call an authorised service agent.
E7	Coil temperature sensor is disabled. Call an authorized service agent.
E8	Cooler temperature sensor is disabled. Call an authorized service agent.

EA	Large Coil Saturation Error. Switch the hob off by pressing on/off button, switch the hob on by pressing on/off button and continue to use. If the same error is displayed again, call an authorised service agent.
EC	Supply Voltage Error. Switch the hob off by pressing on/off button, switch the hob on by pressing on/off button and continue to use. If the same error is displayed again, call an authorised service agent.
C1-C8	Microprocessor alert. Switch the hob off by pressing on/off button, switch the hob on by pressing on/off button and continue to use. If the same error is displayed again, call an authorised service agent.

5. CLEANING AND MAINTENANCE

5.1 Cleaning

 **WARNING:** Switch off the appliance and allow it to cool before cleaning is to be carried out.

General Instructions

- Check whether the cleaning materials are appropriate and recommended by the manufacturer before use on your appliance.
- Use cream cleaners or liquid cleaners which do not contain particles. Do not use caustic (corrosive) creams, abrasive cleaning powders, rough wire wool or hard tools as they may damage the cooker surfaces.

 Do not use cleaners that contain particles, as they may scratch the glass, enamelled and/or painted parts of your appliance.

- Should any liquids overflow, clean them immediately to avoid parts becoming damaged.

 Do not use steam cleaners for cleaning any part of the appliance.

Cleaning the Ceramic Glass

Ceramic glass can hold heavy utensils but may be broken if it is hit with a sharp object.

 **WARNING :** Ceramic Cooktops - if the surface is cracked, to avoid the possibility of an electric shock, switch off the appliance and call for service.

- Use a cream or liquid cleaner to clean the vitroceramic glass. Then, rinse and dry them thoroughly with a dry cloth.



 Do not use cleaning materials meant for steel as they may damage the glass.

- If substances with a low melting point are used in the cookware's base or coatings, they can damage the glass-ceramic cooktop. If plastic, tin foil, sugar or sugary foods have fallen on the hot glass-ceramic cooktop, please scrape it off the hot surface as quickly and as safely as possible. If these substances melt, they can damage the glass-ceramic cooktop. When you cook very sugary items like jam, apply a layer of a suitable protective agent beforehand if it is possible.
- Dust on the surface must be cleaned with a wet cloth.
- Any changes in colour to the ceramic glass will not affect the structure or durability of the ceramic and is not due to a change in the material.

Colour changes to the ceramic glass may be for a number of reasons:

1. Spilt food has not been cleaned off the surface.
2. Using incorrect dishes on the hob will erode the surface.
3. Using the wrong cleaning materials.

Cleaning the Stainless Steel Parts (if available)

- Clean the stainless steel parts of your appliance on a regular basis.
- Wipe the stainless steel parts with a soft cloth soaked in only water. Then, dry them thoroughly with a dry cloth.
-  Do not clean the stainless steel parts while they are still hot from cooking.
-  Do not leave vinegar, coffee, milk, salt, water, lemon or tomato juice on the stainless steel for a long time.

6. TROUBLESHOOTING&TRANSPORT

6.1 Troubleshooting



If you still have a problem with your appliance after checking these basic troubleshooting steps, please contact an authorised service person or qualified technician.

Problem	Possible Cause	Solution
Hob control card's display is blacked out. The hob or cooking zones cannot be switched on.	There is no power supply.	Check the household fuse for the appliance. Check whether there is a power cut by trying other electronic appliances.
The hob switches off while it is in use and an 'F' flashes on each display.	The controls are damp or an object is resting on them.	Dry the controls or remove the object.
The hob switches off while it is in use.	One of the cooking zones has been on for too long.	You can use the cooking zone again by switching it back on.
The hob controls are not working and the child lock LED is on.	Child lock is active.	Switch off the child lock.
The saucepans make noise during cooking or your hob makes a clicking sound during cooking.	This is normal with induction hob cookware. This is caused by the transfer of energy from the hob to the cookware.	This is normal. There is no risk, neither to your hob nor to your cookware.
The 'U' symbol lights up in the display of one of the cooking zones.	There is no pan on the cooking zone, or the pan is unsuitable.	Use a suitable pan.
Power level 9 or 'P' is automatically reduced. If you select power level 'P' or 9 on two cooking zones, which are on the same side, at the same time.	Maximum power level for the two zones is reached	Operating both zones at power level 'P' or 9 would exceed the permitted maximum power level for the two zones.

6.2 Transport

If you need to transport the product, use the original product packaging and carry it using its original case. Follow the transport signs on the packaging. Tape all independent parts to the product to prevent damaging the product during transport.

If you do not have the original packaging, prepare a carriage box so that the appliance, especially the external surfaces of the product, is protected against external threats.

7. TECHNICAL SPECIFICATIONS .

7.1. ENERGY CLASS

Brand		
Model		EBI444
Type of hob		ELECTRIC
Number of cooking zones		4
Heating Technology 1		Induction
Size 1	cm	Ø16,0
Energy consumption 1	Wh/kg	182,0
Heating Technology 2		Induction
Size 2	cm	Ø16,0
Energy consumption 2	Wh/kg	182,0
Heating Technology 3		Induction
Size 3	cm	Ø21,0
Energy consumption 3	Wh/kg	182,0
Heating Technology 4		Induction
Size 4	cm	Ø21,0
Energy consumption 4	Wh/kg	182,0
Energy consumption of hob	Wh/kg	182,0
This hob complies with EN 60350-2		
Energy Saving Tips		
Hob		
<ul style="list-style-type: none">- Use cookwares having flat base.- Use cookwares with proper size.- Use cookwares with lid.- Minimize the amount of liquid or fat.- When liquid starts boiling, reduce the setting.		

52289127

