



# ELECTRICAL WATER HEATER

WHSM35/50/65/80/100

WHSD35/50/65/80/100

WHSD50/65/80/100

USER MANUAL

## Dear Customer,

First of all, congratulations for choosing a nature and technology friendly VOX product.

Aspiring to present products above and beyond your expectations, which is manufactured meticulously at VOX's modern plants and rigorously quality-controlled, into your use. This operating manual will guide you through the use of your appliance. You will see that your appliance is equipped with the most advanced technological solutions and quite easy to use.

The life of your appliance will prolong if you perform necessary care and maintenance procedures.

We hope you enjoy using your appliance.

## Important Information on Safety

This operating manual includes important information on getting your appliance started, and its safety, intended use, cleaning and maintenance.

Always keep this operating manual with your appliance. Whenever you lend your appliance, give this operating manual as well.

Read the operating manual carefully before using your appliance to prevent burns, electric shocks, fire or injury risk, and follow the instructions on operating your appliance, troubleshooting and cleaning.

The water heater must be mounted by VOX Authorized Service. The water heater must absolutely be grounded.



**WARNING: Denotes death or severe injury risk.**



**CAUTION: Denotes injury or property damage risk.**

# Contents

<b>Safety Warnings</b> .....	<b>5</b>
Safety Information on the Installation of the Appliance .....	5
Safety Information on the Use of the Appliance .....	6
Safety Information to Take into Consideration During Cleaning and Maintenance .....	9
Safety Information to Take into Consideration During Handling and Transportation .....	9
<b>Installation</b> .....	<b>10</b>
Choosing the Mounting Position .....	10
<b>Liability Limitation</b> .....	<b>10</b>
<b>Technical Specifications (WHSM / WHSD)</b> .....	<b>11</b>
<b>Technical Specifications (WHSDDB)</b> .....	<b>12</b>
Electrical Connections .....	14
<b>General View (Analog)</b> .....	<b>15</b>
<b>General View (Digital)</b> .....	<b>16</b>
<b>General View (Digital Turbo)</b> .....	<b>17</b>
<b>Functions and Features of the water heater</b> .....	<b>18</b>
Strength against corrosion .....	18
Strength against water pressure .....	18
Effective Heat Isolation .....	18
Limiting Thermostat.....	18
Safety Valve .....	18
Anti-freeze Safety (*).....	18
Dry Operation Safety(*).....	18
Low Voltage Safety(*) .....	18
Smart Cleaning System(*).....	18
Extra Rapid Heating (*) .....	19
Economy Mode (*).....	19
<b>Operating</b> .....	<b>19</b>
Analog.....	19
Digital/Digital Turbo .....	19
<b>Practical and Useful Information</b> .....	<b>20</b>
<b>Suggestions for Operation</b> .....	<b>20</b>

<b>Cleaning and Maintenance .....</b>	<b>21</b>
<b>Recommendations on Energy Saving .....</b>	<b>21</b>
<b>Troubleshooting.....</b>	<b>22</b>

## **Safety Warnings**

### **Safety Information on the Installation of the Appliance**

**WARNING:** Using voltage of your water heater is 230 Volt.

**WARNING:** Make sure that safety valve is installed on to the cold water inlet. Safety valve has been set during the manufacturing of the product. The setting mechanism should not be intervened. High pressure water will flow from safety valve. This is not a fault and is required according to safety standard.

**WARNING:** The water heater must absolutely be grounded. If you use your water heater without plug, absolutely run your appliance after connecting to grounded power line by means of fuse; if you use your water heater with plug, absolutely run it by inserting into the grounded plug. **Manufacturing company shall not be responsible for any damage due to operating without grounding.**

**WARNING:** Do not operate your water heater without making sure that it is filled with full of water. If water is flowing when

you open the hot water tap, it means that the appliance is full of water.

**WARNING:** When the water heater will be mounted and operated for the first time, ask an authorized VOX service for help.

**WARNING:** Avoid installing the water heater in places where there is a risk of freezing.

**WARNING:** Do not use electricity extension cables or multipliers.

**WARNING:** This appliance is not intended to be used by those with physical, sensorial and mental disability (including children) or with lack of experience and knowledge unless they are given supervision and method by a person, who is responsible for the safety of the appliances, about using the appliance.

**WARNING:** If the power cable is damaged, it should be replaced by the VOX authorized service staff in order to avoid a dangerous situation.

- Installation and repairs should always be done by Authorized Service.
- Producing company shall

not be held responsible of any damage due to operations conducted by unauthorized persons.

**WARNING:** Your water heater has been manufactured for domestic use, and can be used only at home and for specified purposes. It is not suitable for commercial or common usage.

**WARNING:** The water hotter than 50°C during usage can cause scalding or even death due to serious scalding. Please keep in mind that children, elderly and disabled people are more vulnerable to the risk of burning.

### **Safety Information on the Use of the Appliance**

**WARNING:** The limiting thermostat will disable the resistance in case of excessive temperatures in the boiler or the failure of temperature setting thermostat.

**WARNING:** Safety valve is installed on to the cold water inlet of the water heater. This will prevent the draining of the water inside in case of a water cut.

**CAUTION:** The following

conditions must be observed while installing and using the safety valve.

- As water may drip from the drainage tip, this pipe should be left open to the atmosphere. In order to prevent the dripping waters from causing any harm to the environment, you can connect it to a sewage drain by means of a hose.
- The appliance should be operated with intervals in order to prevent limescale accumulation and confirm that it is not blocked.
- While connecting the safety valve to the appliance, make sure that the drainage tip is downwards.
- Operation of the appliance for purposes other than its intended purpose may cause damage or dangerous conditions and renders the warranty void. Damages occurred due to these environments are compensated by the user.
- In order to prevent overloading of the electrical circuit, do not operate any other

- high-power appliance on the same circuit. Do not connect with extension cables or multi plugs. If you neglect, it may cause electric shocks and damages in the product.
- This appliance can be used by children at the age of 8 years old or above and by those with physical, sensorial and mental disability or with lack of experience and knowledge, provided that they are given supervision and instruction about safely use of the appliance and that the hazards caused by the appliance are understood by them.
  - Safety valve mains used in the appliance may cause leakage at the drainage section if the water pressure exceeds 8 bars. This is normal. When the pressure reduces, the leakage will stop.
  - As corrosion may be sped up if the water inside the appliance is discharged and the appliance stays empty for a long time, the reservoir should not stay water-free for a long time.
  - Children should not be allowed to play with the appliance.
  - Cleaning and user maintenance should not be done by unattended children.
  - Packaging materials are dangerous for children. Keep all packaging materials out of the reach of children.
  - Before use, check the functions of your appliance accurately.
  - The appliance should be used only if it is plugged in a power cable and it has no visible damages on its body.
  - Check the power cable for damages regularly. Do not strain the power cable of the appliance. Do not put any object on the power cable.
  - If the power cable is damaged, it should be replaced by the authorized service recommended by the producer in order to avoid any danger.
  - In case that the mains operating pressure exceeds 8 bars, a pressure reducer should be connected to the cold water line before safety

ventile. The pressure reducer should be away from the appliance and close to the counter as much as possible.

**Never use your appliance under the following conditions:**

- If the appliance or the power cable is damaged,
- If the appliance does not function properly,
- If the electrical components of the appliance are visibly damaged,
- If the appliance is wet, has fallen into water or any other liquid, exposed to water flooding incident, its electrical components have come into contact with water,
- If strange noises, smoke or smell emanate from the appliance.

If any of the cases mentioned above is detected, shut down your appliance immediately, disconnect the power supply connection and contact with the authorized service.

- A damaged appliance or damaged parts of the appliance may cause severe injuries and fire.

- There is no parts within the appliance, with which the user can intervene. The risk of electric shock occurs when electrical connections within the appliance are touched and when the mechanical structure of the appliance is changed. In case of any failure, do not attempt to repair it yourself. Otherwise, the appliance shall be void of warranty.
- Use of accessories not recommended by the producer may cause injuries and damages in the appliance.
- Do not touch or run the appliance with wet and moist hands.
- If the appliance will not be used for a long time, disconnect the power supply from the fuse.

Make sure that the appliance is turned off and the power is cut from the fuse/power switch at the following conditions:

- Before installation,
- Before cleaning and maintenance,
- Before repairs.
- Do not drink the water



drained off from the appliance. Otherwise, severe health problems may occur.

- If the appliance will be re-mounted at a new location, contact with the authorized service.

### **Safety Information to Take into Consideration During Cleaning and Maintenance**

- To prevent risk of electric shock, turn off the appliance, shut down its fuse or switch gear before cleaning.
- All maintenance and service works should be performed by the authorized VOX services.
- Magnesium bar used against the corrosion inside the drum should be checked every year and if it worn out, it should be replaced by the authorized service.
- To get the optimum performance from your electrical water heater, it is recommended to perform the cleaning of the limescale that may form on the resistance due to the water hardness and the high temper-

atures should be removed in every two years regularly by the Authorized Service. This procedure should be performed on heating resistance.

- All above-mentioned procedures should be performed by VOX Authorized Service.
- Hot water, ammoniac and non-alcohol containing liquid detergents should be used. Otherwise the surface may get damaged.
- Clean and maintain the appliance as stated in the "Cleaning and Maintenance" section.
- Do not use chemicals. Do not use substances such as gasoline, thinner etc.
- Using powder detergent may result in scratches on the surface of the water heater.

### **Safety Information to Take into Consideration During Handling and Transportation**

While handling the appliance,

make sure that all electrical connections are removed and all water inside is discharged. Place or hold the appliance in a way to avoid damaging during handling.

## **Installation**

**WARNING:** The water heater should be installed by VOX Authorized Service according to “Installation Instructions”.

**WARNING:** The appliance should not be mounted on the stairs, exits and hallways of the building.

Type C 16A fuse should be used in the appliance. Your appliance is not suitable for being used outside the building.

## **Choosing the Mounting Position**

- Do not install the appliance in non-ventilated and humid areas.
- Do not place the appliance to areas that are under direct sun light.
- Do not place the appliance in areas where partially dangerous substances such as

steam, dust or gas are present.

- Do not connect the appliance directly to the electricity sources which are not protected from the sudden voltage spike.

## **Liability Limitation**

All technical information, instructions for use, operating and maintenance of the appliance included in this manual are the most up to date information on your appliance. Manufacturer does not assume any responsibility for damages and injuries that may occur as a result of non-compliance with the instructions given in this manual, using the appliance for purposes other than its intended use, unauthorized repairs, unauthorized modifications on the appliance and using spare parts that are not approved by the manufacturer.

# Technical Specifications (WHSM / WHSD)

	WHSM35	WHSM50	WHSM65	WHSM80	WHSM100
Model	WHSD35	WHSD50	WHSD65	WHSD80	WHSD100
Capacity	Lt. 35	50	65	80	100
Water Temperature Setting Range	°C 25-75	25-75	25-75	25-75	25-75
Voltage	V 220-240	220-240	220-240	220-240	220-240
Current	A 7	9	9	9	9
Resistance Power	W 1500	2000	2000	2000	2000
The Highest Operating Pressure of Safety Valve	Bar 10 (-0.5, +0)	10 (-0.5, +0)	10 (-0.5, +0)	10 (-0.5, +0)	10 (-0.5, +0)
Water Connection	Inch 1/2	1/2	1/2	1/2	1/2
Protection Class	IP24	IP24	P24	IP24	IP24
Anti-Corrosive System	Enameled Interior Drum and Magnesium Bar				
Product Sizes	mm 430x456x481	430x456x631	430x456x761	430x456x891	430x456x1054

Technical specifications and this manual are subject to change without prior notification.



This appliance conforms to Regulation on Supervision of the Waste Electric and Electronic Appliances.



This product complies with the Europe CE Directives no. 2014/130/EU (Electromagnetic Compliance Regulation) and 2014/35/EU (Low Voltage (LVD) Regulation)

# Technical Specifications (WHSDB)

Model	WHSDB50	WHSDB65	WHSDB80	WHSDB100
Capacity	Lt. 50	65	80	100
Water Temperature Setting Range	°C 25-75	25-75	25-75	25-75
Voltage	V 220-240	220-240	220-240	220-240
Current	A 13,5	13,5	13,5	13,5
Resistance Power	W 3000	3000	3000	3000
The Highest Operating Pressure of Safety Valve	Bar 10 (-0.5, +0)	10 (-0.5, +0)	10 (-0.5, +0)	10 (-0.5, +0)
Water Connection	Inch 1/2	1/2	1/2	1/2
Protection Class	IP24	P24	IP24	IP24
Anti-Corrosive System	Enameled Interior Drum and Magnesium Bar			
Product Sizes	mm 430x456x631	430x456x761	430x456x891	430x456x1054

Technical specifications and this manual are subject to change without prior notification.



This appliance conforms to Regulation on Supervision of the Waste Electric and Electronic Appliances.



This product complies with the Europe CE Directives no. 2014/130/EU (Electromagnetic Compliance Regulation) and 2014/35/EU (Low Voltage (LVD) Regulation)

The distances specified in the chart below should be applied in the installation of the appliance.

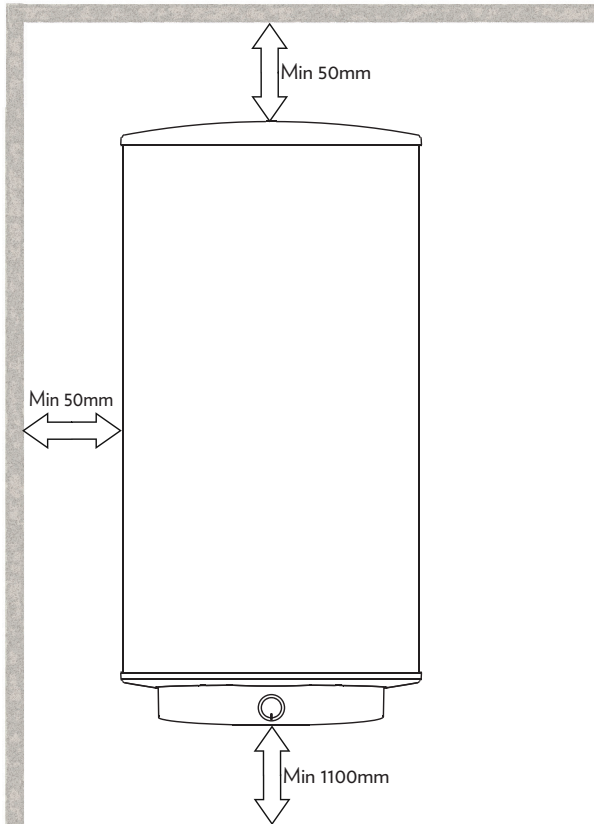

# Electrical Connections

## Analog

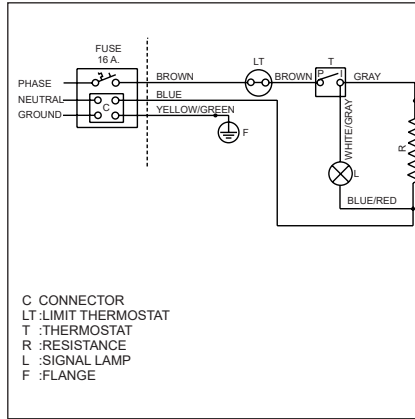

## Digital

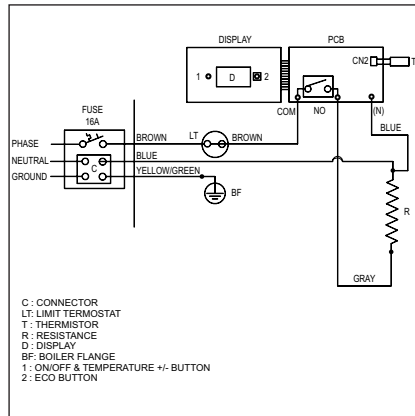

## Digital Turbo

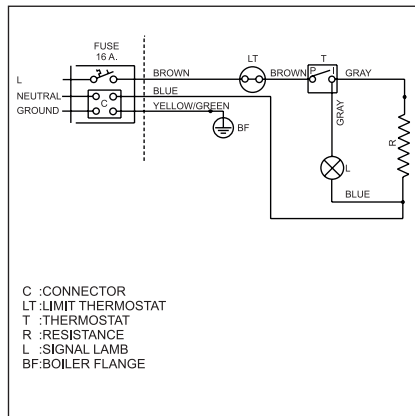

## General View (Analog)

The images in the user manual are for informational purposes only about the parts of the device. Parts may differ depending on the device model. Pictures are representative.

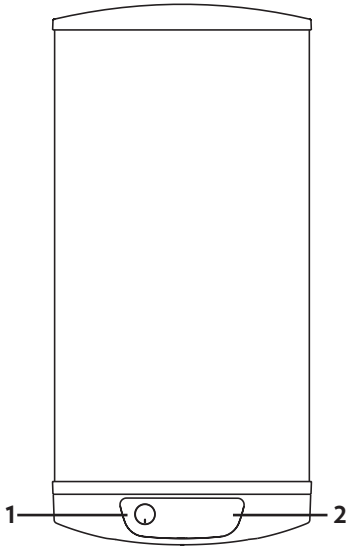

1. ON/OFF and temperature setting button
2. Status indicators

## Controls and Indicators

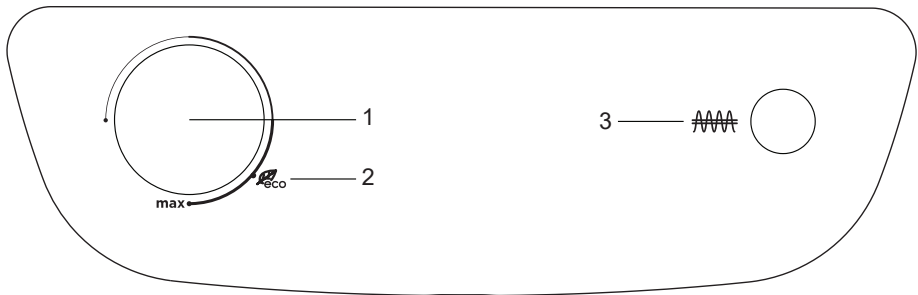

1. ON/OFF and temperature setting button
2. Eco mod indicator
3. Resistance/Hot water lamp

# General View (Digital)

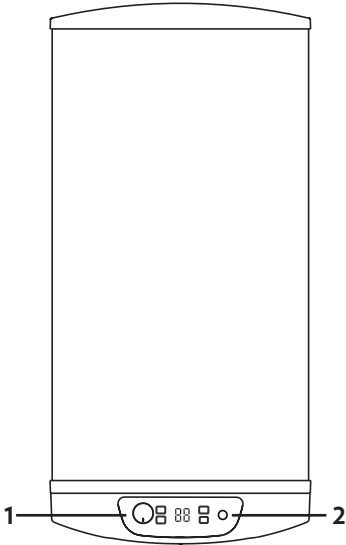

1. ON/OFF and temperature setting button
2. Status indicators

## Controls and Indicators

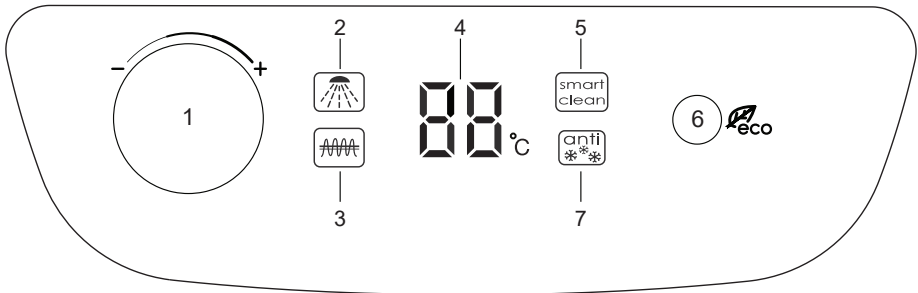

1. ON/OFF and temperature setting button
2. Hot water led
3. Resistance led
4. Temperature display
5. Smart clean led
6. Eco led
7. Anti Freeze led



# General View (Digital Turbo)

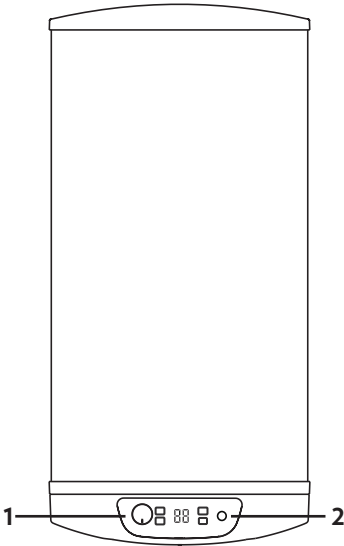

1. ON/OFF and temperature setting button
2. Status indicators

## Controls and Indicators

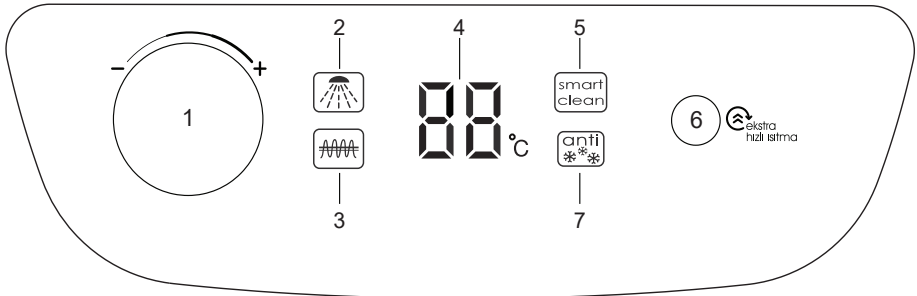

1. ON/OFF and temperature setting button
2. Turbo heating led
3. Resistace led
4. Temperature display
5. Smart clean led
6. Turbo heating button
7. Anti Freeze led

## Functions and Features of the water heater

The features marked with (\*) works with only digital models

### Strength against corrosion

The inner drum of your water heater, including the water input and output pipes are enamel plated following the welding operation are fully protected against corrosion. The heater resistance is protected against corrosion with Magnesium bar.

### Strength against water pressure

Water heater's inner drum is tested under 12 bar pressure considering the water mains pressure.

### Effective Heat Isolation

The water heater is isolated using a 50mm thick polyurethane heat isolation material between the main body sheet and the water drum. Thank to this material the water in it will be heated rapidly and cools down slowly.

### Limiting Thermostat

The limiting thermostat will disable the resistance in case of excessive temperatures in the drum or the failure of temperature setting thermostat.

### Safety Valve

Safety valve is installed on to the cold water inlet of the water heater. A kind of safety, this valve will prevent the draining of the water inside in case of a water cut. Also the same valve will discharge water

from the drain tip in case of overpressure in the boiler.

### Anti-freeze Safety (\*)

When the water temperature inside the water heater drop below 5°C, the heating resistance is automatically activated and heats the water up to 16°C. **RF** symbol will be displayed during anti freeze system work. The anti-freeze safety system activates while the water heater is in stand-by. Install the water heater in a location without risk of freezing.

### Dry Operation Safety(\*)

If the device is operated without water due to any possible reason, the system will intervene automatically and E3 error code is displayed. In this case, disconnect the power of the device and ensure that the water heater is filled with water. After ensuring that it is filled with water reconnect to the mains supply, the water heater will commence its normal operation.

### Low Voltage Safety(\*)

If voltage is dropped to level harmful for the device due to voltage fluctuations then the low voltage safety system is activated and E2 is displayed. After the voltage is restored to normal level E2 error will be cleared and the water heater will commence its normal operation.

### Smart Cleaning System(\*)

When the water is kept under below 60°C for a long time it will become suitable for bacteria growth. While the device in stand-by, to prevent bacteria from growing the water is heated at least once a week above 65°C and kept at this level

for 1 hour. If the water heater is set manually to 65°C or higher, then this system will automatically activate 1 week later following this last usage and automatically heats the water above 65°C.

## Extra Rapid Heating (\*)

Extra Rapid Heating function allows you to gain time by heating the water faster than normal in emergencies thanks to the additional heater. Press  to activate or deactivate Extra Rapid Heating function.

## Economy Mode (\*)

The water hotter than 50°C during usage can cause scalding or even death due to serious scalding. The temperature which is most favorable for human health and energy economy is about 55°C. This temperature is indicated on the front panel of the product with a  icon. You can operate the product in an economical way setting the temperature setting knob to eco icon.

## Operating Analog

After your water heater is installed and operationalized by the authorized service, you can turn it on by pushing the on/off button on the front panel.

- Ensure that the water heater is filled with water before the initial use.
- During the initial operation the temperature set will flash on the display panel. After a short interval the flashing will stop and the current inner temperature will be displayed.

You can set the desired temperature using the up and down arrows found next to the display. After setting the temperature resistance is activated and the resistance indicator on the left bottom becomes active.



- When the water temperature reaches the target temperature the resistance will be deactivated and the resistance indicator will flash and the shower sign will be activated. In this case the hot water is ready to use.
- When the temperature lowers to a level 4 degrees below the set temperature, the resistance will be activated again and the water is heated to the target temperature.

## Digital/Digital Turbo

After your water heater is installed and made ready for use by the authorised service, you can switch it on by turning the temperature adjustment knob on the control panel.

- Ensure that the water heater is filled with water before first use. Switch on the V Automated switch.
- During the initial operation the temperature set will flash on the display panel. After a short interval the flashing will stop and the current inner temperature will be displayed. To heat the water to the desired temperature, turn the temperature adjustment knob clockwise. Stop turning it when the digital display panel shows the desired temperature.
- When you set the temperature to 55°C with button next to the indicator in order to activate the ECO function, “EL” will appear in the tem-

perature indicator. When you set the temperature again with the button or switch off your water heater, the ECO function will be terminated.

- After setting the temperature, the resistance is activated and the resistance indicator on the left bottom corner becomes active.
- When the water temperature reaches the target temperature the resistance will be deactivated and the resistance indicator will flash and the shower sign will be activated. When this happens, your hot water is ready for use.
- When the temperature drops to a level 4 degrees below the set temperature, the resistance will be activated again and the water is heated to the set temperature.
- When the set temperature is below 25°C, water heater will be switched off automatically.
- Press  to activate Extra Rapid Heating function. Your water heater will activate the additional heater and start rapid heating until the water reaches the set temperature. When the water reaches the temperature you have set, rapid heating ends and the additional heater stops working. You can deactivate the function at any time before the water reaches the desired temperature by pressing .

## Practical and Useful Information

- The sediments and limescale accumulated at the below section of the water heater will prevent direct contact between the water and the heating elements. Accumulation of sediments and limescale at the bottom of the water boiler should be prevented. The water boiler should be drained at regular intervals.
- Heat required amount of water in your water heater. Install the water heater away from the appliances such as refrigerator and deep-freezer. Otherwise operation frequency will increase.
- Ensure that isolation is installed to prevent heat loss from the boiler and installation.
- The water heater should be located max. 6 m away from the points of use. Installation on a farther location will cause a drop at the efficiency of heat transfer. Also the water piping should be isolated.
- When the device is not going to be used for a prolonged time set the thermostat to the lowest setting.

## Suggestions for Operation

- Do not place items that are vulnerable to water beneath the water heater.
- Take below precautions if you will not use the product for a prolonged time.
  - Disconnect the product from the mains supply.
  - Switch off the water valves and disconnect the water connection.

## **Cleaning and Maintenance**

**Disconnect from the electrical mains before handling any operation.**

- Install a transparent drain hose to the drain output of the safety valve located at the cold water input of the water heater at a location away from freezing.
- Pressure will increase with the operation of the water heater. Dripping of water at the safety valve is normal.
- Drain water from the boiler setting the safety valve latch to upright position. To check the operation of the safety valve, it is recommended to set the latch to upright position once a month to see if water flows out.
- If water is drained through safety valve, do not operate until water comes from the hot water tap.
- To get the optimum performance from your electrical water heater, limescale that may form on the resistance due to the water hardness and the high temperatures should be removed regularly by the Authorized Service.

## **Recommendations on Energy Saving**

- It is recommended to operate the product in Eco mode (55°C) to extend the life of the product and save energy.
- To get the best possible performance from the product the heating element (resistance) should be cleaned and the magnesium bar for corrosion protection should be replaced once in every 2 years. The cleaning and replacement should be performed by an authorized service.
- Anode and heater should be checked annually in regions with higher water hardness.

## Troubleshooting

Before calling the service ensure that the failure is not related with a temporary electrical black out or water cut.

In case you observe an abnormality in your appliance, you may try to solve the problem according to the instructions below. If your appliance does not still operate properly, contact the Call Center. You may access the authorized services list and contact information from the web site.

PROBLEM	REASON	SOLUTION
Water heater is not operating	Switch is off.	Turn on the switch.
	Power cut.	Wait for the power to be back.
	Building's main fuse is blown.	Fix the fuse.
Water heater is not heating the water.	Water heater is not operating correctly.	Call the authorized service.
Water heater is heating the water too late.	Voltage may be low.	Use an appropriate voltage regulator.
	Limescale may be formed on the resistance.	Call the authorized service.
Noisy operation.	Limescale may be formed on the resistance.	Call the authorized service.
	Limescale or sand can be present within the safety valve.	Call the authorized service.
	System pressure can be distributed irregularly.	Install a pressure regulator.
Water heater heats water excessively (water steam comes out).	There might be too much limescale in the product.	Call the authorized service.
Water drips from the safety valve.	This is normal.	Connect the provided hose from the valve to water drainage.

### Digital models error messages

ERROR MESSAGE	REASON	SOLUTION
E1 (E1)	Thermistor Error	Call the authorized service.
E2 (E2)	Low Voltage Warning	The error will be cleared after the voltage becomes normal.
E3 (E3)	Dry operation	After filling the boiler with water, disconnect and connect the power supply of the product.