



GBR

SRB

# SL-307

OPERATING INSTRUCTIONS VACUUM CLEANER

UPUTSTVO ZA UPOTREBU USISIVAČ



GBR

# INSTRUCTION MANUAL VACUUM CLEANER

MODEL: SL-307

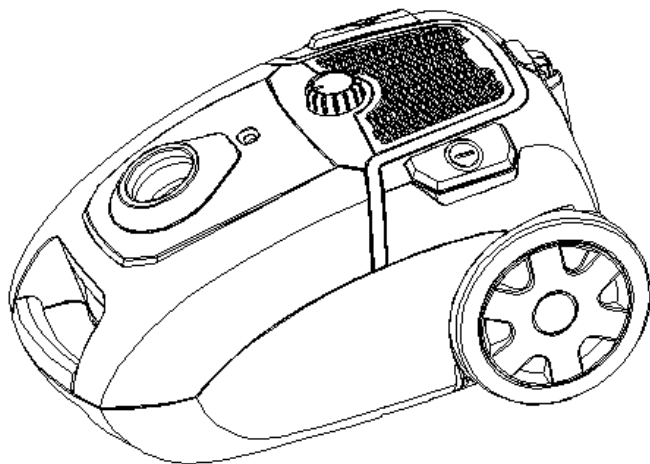

PLEASE READ THIS MANUAL CAREFULLY BEFORE USE  
AND KEEP IT PROPERLY FOR FUTURE REFERENCE

# IMPORTANT SAFEGUARDS

1. Read this instruction booklet carefully.
2. Before using the appliance, check if the mains power voltage corresponds to the voltage shown on the rating plate.
3. The appliance should be connected to a correctly-earthed 10A power socket.
4. Always remove the plug from the power socket when the appliance is not in use and before cleaning or maintenance.
5. Always remove the plug from the power socket before opening the appliance.
6. Never use methylated spirits or other solvents to clean the appliance.
7. Do not use the appliance to vacuum liquids.
8. Never leave the appliance unattended when it is switched on. Keep the appliance out of the reach of children or the infirm.
9. This appliance is only for household. Use as described in this instruction booklet.
10. Do not switch the appliance on if it appears to be faulty in any way.
11. For repairs or accessories, contact your dealer or an authorized Service Center.
12. If the supply cord is damaged, it must be replaced by the manufacturer, its service agent or similarly qualified persons in order to avoid a hazard.
13. This appliance is not intended for use by persons (including children) with reduced physical, sensory or mental capabilities, or lack of experience and knowledge, unless they have been given supervision or instruction concerning use of the appliance by a person responsible for their safety.
14. Children should be supervised to ensure that they do not play with the appliance.

Do not remove the plug from the socket by pulling the cable or the appliance itself

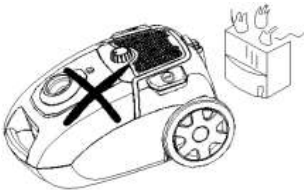

Do not run the appliance over the power cable

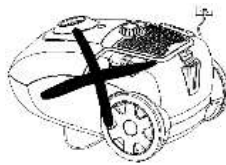

Do not use the appliance to vacuum lighted matches, cigarette ends and hot ash.



Do not use the appliance on wet surfaces



Do not obstruct the air intake or outlet vent

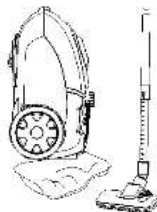

Do not use the appliance to vacuum needles, drawing pins or strings



# KNOW YOUR APPLIANCE

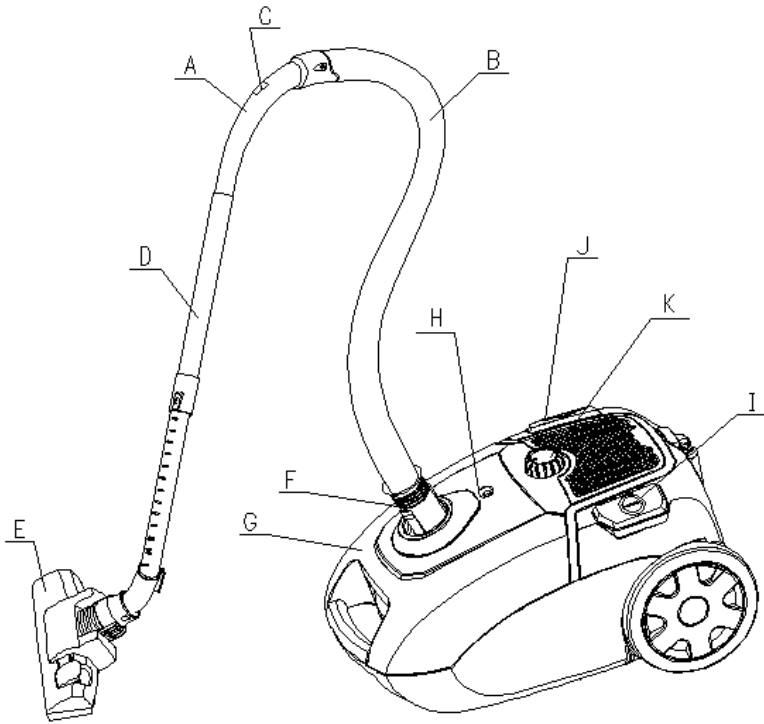

- |                 |                        |                     |              |
|-----------------|------------------------|---------------------|--------------|
| A. Handle       | B. Hose                | C. Airflow Adjuster | D. Tube      |
| E. Floor brush  | F. Hose connector      | G. Front cover      | H. Indicator |
| I. Power switch | J. Cable rewind button | K. Speed controller |              |

## ASSEMBLY

### Removing the flexible tube

Remove the plug from the power socket. To release the flexible tube, press the button on the end of the tube and pull the tube firmly from the air intake duct.

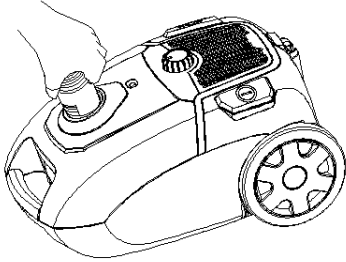

### Fitting the extension tubes and accessories

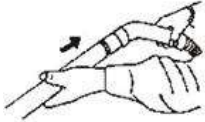

Fitting the extension tube to the handle

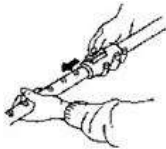

Fitting the extension tubes

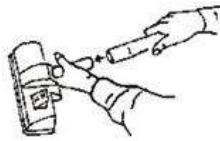

Fitting the accessories to the extension tube

## INSTRUCTION FOR USE

1. Before using the appliance, unwind length of cable and insert the plug into the power socket. The YELLOW mark on the power cable shows the ideal cable length. Do not extend the cable beyond the RED mark. To rewind the power cable, press the rewind button with one hand, and guide the cable with the other hand to avoid wrapping.
2. Press the ON/OFF button to switch the appliance on. It is advisable to set the Speed Controller to MIN before switching the appliance on.
3. By turning the speed control knob, the absorption power can be adjusted.

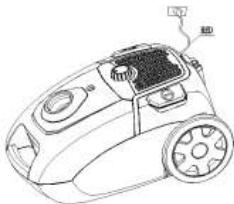

## ACCESSORIES

1. Dual-position brush- carpet/floor



bristles extended for hard floors



bristles retracted for carpets

2. Narrow nozzle (cleaning radiators, corners, edges, drawers etc)

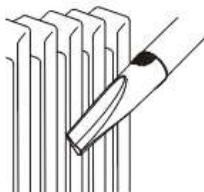

3. Small brush (cleaning curtains, shelves, books, inlaid furniture, lamps and other dedicate objects)



## REPLACING THE DUST BAG

1. After removing the flexible tube, open front cover by pressing the button and puling upwards.
2. Remove the dust bag.

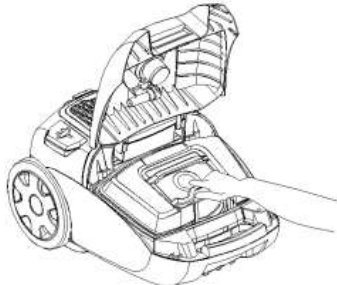

## MAINTENANCE

1. Pull the plug out of the socket before cleaning!
2. Clean the appliance with a dry cloth.
3. Take out the intake or outlet filter when it's getting dirty. Clean it in warm water without any abrasives and put it back when it is completely dry.
4. If you do not want to use this appliance for a period of time, store it on a dry and well ventilated place. Keep it out of reach of children.

## DISPOSAL

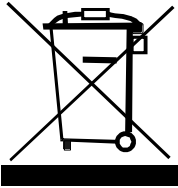

### Environmental Protection

Waste electrical production should not be disposed of with household waste. Please recycle where facilities exist. Check with your Local Authority or retailer for recycling advice.



SRB

# UPUTSTVO ZA UPOTREBU USISIVAČ

MODEL: SL-307

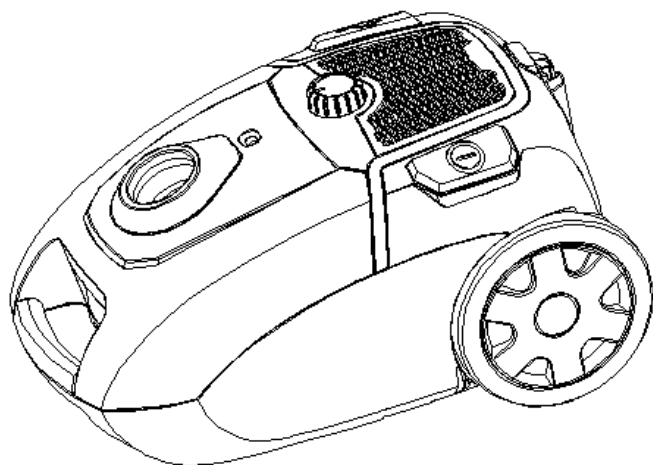

Pažljivo pročitajte ovo uputstvo pre korišćenja i sačuvajte ga za kasniju upotrebu



## VAŽNA BEZBEDNOSNA UPUTSTVA

1. Pročitajte pažljivo celo uputstvo.
2. Pre upotrebe uređaja proverite da li napon napajanja odgovara naponu navedenom na natpisnoj pločici uređaja.
3. Uređaj treba priključiti na ispravno uzemljenu utičnicu od 10A.
4. Uvek isključite utikač iz utičnice kada uređaj nije u upotrebi i pre čišćenja ili održavanja.
5. Uvek isključite utikač iz utičnice pre otvaranja uređaja.
6. Ne koristite alkohol i slične rastvore za šiščenje uređaja.
7. Nemojte koristiti uređaj za usisavanje bilo koje vrste tečnosti.
8. Nikada ne ostavljajte uređaj bez nadzora kada je uključen. Držite uređaj van domašaja dece i nemoćnih osoba.
9. Uređaj je namenjen samo za kućnu upotrebu. Koristite uređaj kako je navedeno u uputstvu.
10. Ne uključujte uređaj ukoliko je na bilo koji način neispravan.
11. Kontaktirajte prodavca ili ovlašćeni servis za sve popravke uređaja i njegove dodatke.
12. Ukoliko je kabl za napajanje oštećen, mora ga zameniti proizvođač ili servisni agent ili slično kvalifikovana osoba kako bi se izbegla bilo kakva opasnost.
13. Ovaj uređaj nije namenjen za upotrebu od strane osoba (uključujući decu) sa smanjenim fizičkim, senzornim ili mentalnim sposobnostima, ili nedostatkom iskustva i znanja, osim ukoliko su pod nadzorom ili su prethodno dobili uputstva o upotrebi uređaja od strane osobe odgovorne za njihovu bezbednost.
14. Deca se ne smeju igrati sa ovim uređajem.

Nemojte vući kabl ili sam uređaj da biste isključili utikač iz utičnice.

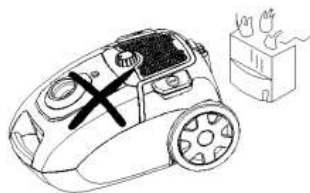

Nemojte prelaziti uređajem preko kabla za napajanje.

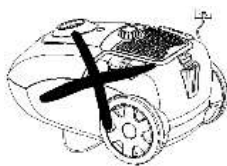

Nemojte koristiti uređaj za usisavanje šibica, opušaka cigareta i vrućeg pepela.



Nemojte koristiti uređaj na vlažnim površinama.



Otvor za ulaz i izlaz vazduha ne sme imati nikakve smetnje.



Nemojte usisavati igle, špenadle i žice ovim uređajem.



## UPOZNAJTE VAŠ UREĐAJ

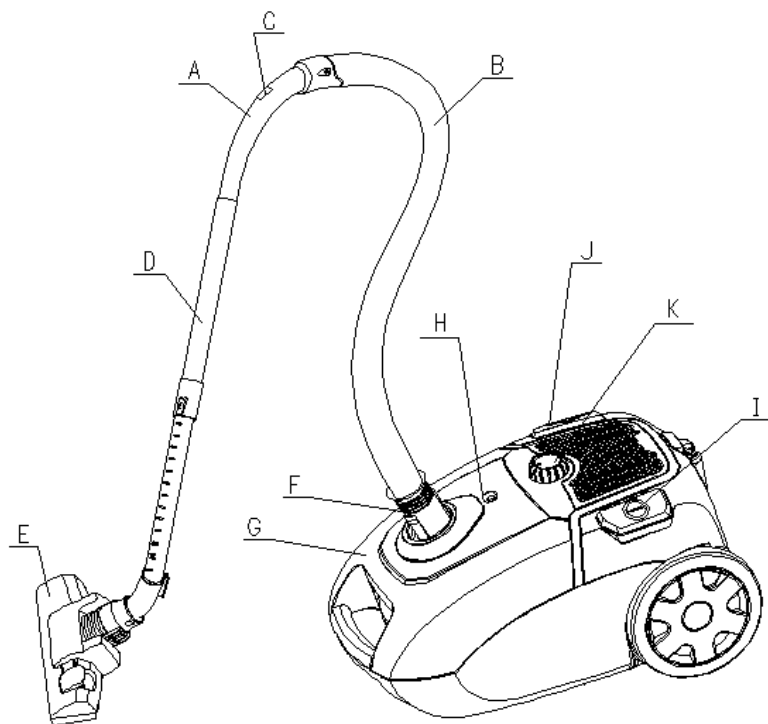

- |                 |                               |                              |              |
|-----------------|-------------------------------|------------------------------|--------------|
| A. Ručka        | B. Crevo                      | C. Regulator protoka vazduha | D. Cev       |
| E. Četka za pod | F. Povezivač za crevo         | G. Prednji poklopac          | H. Indikator |
| I. Prekidač     | J. Dugme za namotavanje kabla | K. Regulator brzine          |              |

## SKLAPANJE UREĐAJA

### Vađenje fleksibilne cevi

Isključite utikač iz utičnice. Da biste izvadili fleksibilnu cev, pritisnite dugme na kraju cevi i izvucite čvrsto cev iz otvora za vazduh.

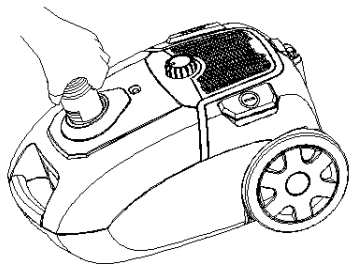

### Sklapanje produžnih cevi i dodataka

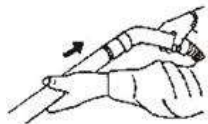

Sklapanje produžne cevi sa ručkom

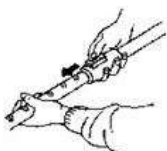

Sklapanje produžne cevi

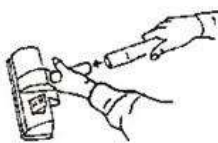

Sklapanje dodatka

## UPOTREBA UREĐAJA

1. Pre upotrebe uređaja, odmotajte kabl i uključite utikač u utičnicu. ŽUTA oznaka na kablju za napajanje pokazuje idealnu dužinu kabla. Nemojte produžavati kabl preko CRVENE oznake. Da biste namotali kabl, pritisnite jednom rukom dugme za namotavanje, a drugom rukom navodite kabl da biste sprečili njegovo uvijanje.
2. Pritisnite ON/OFF dugme da biste uključili uređaj. Preporučljivo je da pre uključivanja uređaja, regulator brzine postavite na MIN.
3. Okretanjem regulatora brzine podešavate snagu uređaja.

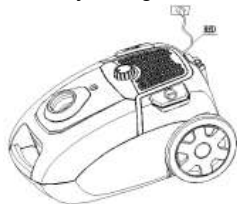

## DODACI

1. Dva položaja četke- tepih/pod



četkasti deo izbačen- za čvrste površine



četkasti deo uvučen- za tepihe

2. Uzani usisni dodatak (čišćenje radijatora, uglova, ivica, fioka i slično)

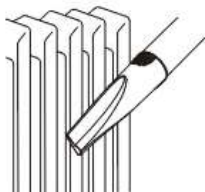

3. Mala četka (čišćenje zavesa, polica, knjiga, nameštaja, lampi i drugih osetljivih predmeta)



## ZAMENA KESE ZA PRAŠINU

1. Sklonite fleksibilnu cev, otvorite prednji poklopac pritiskom na dugme i povucite ga nagore.
2. Izvadite kesu za prašinu.

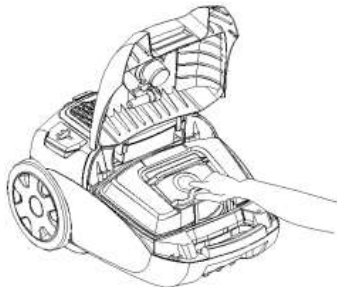

## ODRŽAVANJE

1. Isključite utikač iz utičnice pre čišćenja!
2. Očistite uređaj suvom krpom.
3. Izvadite filter kada se zaprlja. Operite ga u toploj vodi bez abrazivnih sredstava i vratite ga tek kada se potpuno osuši.
4. Ukoliko ne koristite uređaj tokom dužeg perioda, neka bude odložen na suvom mestu sa dobrom ventilacijom. Čuvajte uređaj van domašaja dece.

## ODLAGANJE

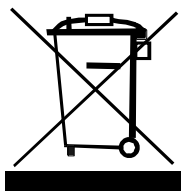

### **Zaštitimo životnu sredinu!**

Elektronski otpad ne sme se odlagati zajedno sa otpadom iz domaćinstva. Reciklirajte na mestima predviđenim za ovu vrstu otpada. Raspitajte se kod vaših opštinskih vlasti ili kod prodavca o recikliranju ove vrste otpada.

