



VOX
ELECTRONICS

ENG

OPERATING INSTRUCTIONS **LED 32DSA314B**
LED 32DSA314H
LED 32DSA316Y

Important Safety Instructions and Maintenance

Important Safety Instructions

CAUTION

Risk of electronic shock, do not open.
Do not attempt to service this product yourself as opening or removing covers may expose you to dangerous voltage or other hazards.
Refer all servicing to qualified service personnel.

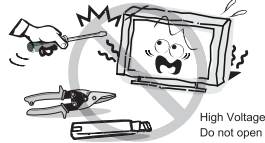

If the following problems occur:
Turn off the TV set and unplug the AC power cord immediately if any of the following problems occur.
Ask your dealer or service centre to have it checked by qualified service personnel

When:

- AC power cord is damaged.
- Poor fitting of AC power outlet.
- TV set is damaged by being dropped, hit or having something thrown at it.
- Any liquid or solid object falls through openings in the cabinet.

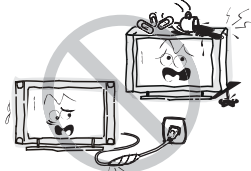

To reduce the risk of fire or electric shock, do not expose this product to rain or moisture.
The apparatus shall not be exposed to dripping or splashing and no objects filled with liquids, such as vases, shall be placed on the apparatus.



The screen and cabinet get warm when the TV is in use. This is not a malfunction. In case of smoke, strange noise or strange smell from the unit:

- Turn off the power switch immediately;
- Disconnect the power plug from the power outlet;
- Contact your dealer or service centre. Never attempt to make repairs yourself because this could be dangerous.

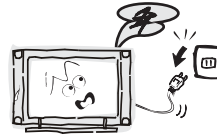

Never push objects of any kind into the set through the cabinet slots as they may touch dangerous voltage points or short-circuit parts that could result in a fire or electric shock. Never spill liquid of any kind on the set. Use special caution in households where children are present. The apparatus is not suitable for children under 3-year to operate.



Do not overload wall outlets, extension cords or adaptors beyond their capacity, this can result in fire or electrical shock.

Power-supply cords should be routed so that they are not likely to be walked on or pinched by items placed upon or against them, paying particular attention to cords at plug end, adaptors and the point where they exit from the appliance. The mains plug is used as the disconnect device. It shall remain readily accessible and should not be obstructed during intended use. Make sure to plug the power cord in until it is firmly inserted. When removing the power cord, make sure to hold the power plug when pulling the plug from the outlet, do not pull the plug out by the wire. NEVER touch the plug or power cord with wet hands. To disconnect the apparatus from the mains power, the plug must be pulled out from the mains socket, therefore make sure the mains plug is always easily accessible.

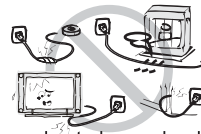

Important Safety Instructions and Maintenance

Important Safety Instructions

Do not push or scratch the front filter, or place any objects on top of the TV set. The image may be uneven or the screen may be damaged.



To avoid the fire, no naked flame source, such as lighted candles, should be placed on the apparatus.

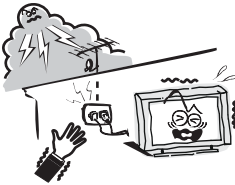

An outside antenna system should not be located in the vicinity of overhead power lines or other electric light or power circuits, or where it can fall into such power lines or circuits. When installing an outside antenna system, extreme care should be taken to keep from touching such power lines or circuits as contact with them might be fatal. Ensuring the television is not overhanging the edge of the supporting furniture.

When not in use

If you will not be using the TV set for several days, the TV set should be disconnected from the AC mains for environmental and safety reasons. As the TV set is not disconnected from the AC power when the TV is turned off at the standby switch, pull the plug from the AC power outlet to disconnect the TV completely. However, some TV sets may have features that require the TV set to be left in standby to function correctly. In the case of lightning, unplug the TV set from the outlet immediately. Never touch the antenna wire during lightning.



Do not pull the plug out by the wire;
Never touch the plug with wet hands.



Excessive volume from earphones and headphones can cause hearing loss.

Installation



The ventilation should not be impeded by covering the ventilation opening with items, such as newspapers, tablecloths, curtains, etc.

At least 10 cm space should be left around the apparatus for sufficient ventilation.



The product should be situated away from heat sources such as radiators, heat registers, stoves, or other products (including amplifiers) that produce heat. Place the apparatus in such a position that the screen is not exposed to direct sunlight. It is best to have soft indirect lighting while watching and avoid completely dark environments and reflection from the screen as these may cause eye fatigue.

Keep the TV set away from any equipment emitting electromagnetic radiation.

Important Safety Instructions and Maintenance

Installation

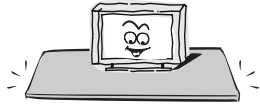

Do not place the set on an unstable cart, stand, table or shelf. The set may fall, causing serious personal injury as well as damage to the product. Use only with the cart, stand, tripod, bracket, or table specified by the manufacturer, or sold with the apparatus. An appliance and cart combination should be moved with care. Quick stops, excessive force, and uneven surfaces may cause the appliance and cart combination to overturn.



Do not place this apparatus near water, for example, near a bath tub, wash bowl, kitchen sink, or laundry tub; in a wet basement; or a swimming pool; and the like;



When the TV being moved in from cold place, it needs some right time for dew inside unit evaporating fully before turn on the unit;



To prevent injury, this apparatus must be securely attached to the floor/wall in accordance with the installation instructions.

LED Screen

Although the LED screen is made with high precision technology and 99.99% or more of the pixels are effective, black dots may appear or bright points of light (red, blue or green) may appear constantly on the LED screen. This is a structural property of the LED screen and is not a malfunction.

If the surface of the LED panel cracks, do not touch it until you have unplugged the AC power cord. Otherwise electric shock may result.

Do not throw anything at the TV set. The LED panel may break from the impact and cause serious injury.

Precautions When Displaying a Still Image

A still image may cause permanent damage to the TV screen.

Do not display still images and partially still images on the LED panel for more than 2 hours as it can cause screen image retention. This image retention is also known as "screen burn". To avoid such image retention, reduce the degree of brightness and contrast of the screen when displaying a still image. Watching the LED TV in 4:3 format for a long period of time may leave traces of borders displayed on the left, right and centre of the screen caused by the difference of light emission on the screen. Playing a DVD or a game console may cause a similar effect to the screen. Damages caused by the above effect are not covered by the Warranty.

Displaying still images from Video games and PC for longer than a certain period of time may produce partial after-images. To prevent this effect, reduce the 'brightness' and 'contrast' when displaying still images.

Cleaning



Cleaning and handling the screen surface and cabinet. Disconnect the unit from the AC outlet before cleaning. To remove dust, wipe gently with a soft, lint free cloth. If required use a slightly damp cloth.



MAINSPLUG

Wipe the mains plug with a dry cloth at regular intervals. Moisture and dust may lead to fire or electrical shock.



Use care not to subject the TV's surfaces to detergent. (A liquid inside the TV could lead to product failure, fire or electrical shock.)

Use care not to subject surfaces to bug repellent, solvent, thinner, or other volatile substances as this may deteriorate the surface and finish of the cabinet.

Contents

General description	5
Specifications and Accessories	6
Overview	7
Remote control	8
First Time Setup	10
Menu Operation	12
Media Menu	28
External connection	33
Trouble shooting	34
Picture defects and countermeasures	36

General Description

Feature:

- Auto tuning and fine tuning
- One mini YPbPr input socket
- Two HDMI inputs socket(HDMI 1.4)
- One mini AV input socket
- Support USB
- One Coaxial output
- Wide range voltage input

Note:

1. In case of any design change, a notice will not be released.

Specifications And Accessories

Specifications:

Description	LED 32DSA314B / LED 32DSA314H/ LED 32DSA316Y
Display Screen Type	Color active matrix LED display
Display size	32" Diagonal(max.)
The maximum resolution	1366X768
Power supply	100-240V~ 50/60Hz
TV receive system	Digital: DVB-T/T2 , DVB-C, DVB-S/S2 Analog: PAL/SECAM
Frequency range	48.25~863.25MHz
Video in	PAL/NTSC
Antenna input impedance	75Ω
Sound output	2x8W
Power supply for remote controller	DC 3V (Two AAA size batteries)
Power consumption	65 W
VGA support resolution	640x480/800x600 1366x768
HDMI support resolution	480P 570I/P 720I/P
Operation environment temperature	0°C-40°C

Accessories

- User's manual
- Remote control
- Wall-mounted accessories(Optional)

Note: Due to TV may be used with different display screen, weight marked in this user's manual or in packaging box are subject to change without notice.

TV Terminal Connections

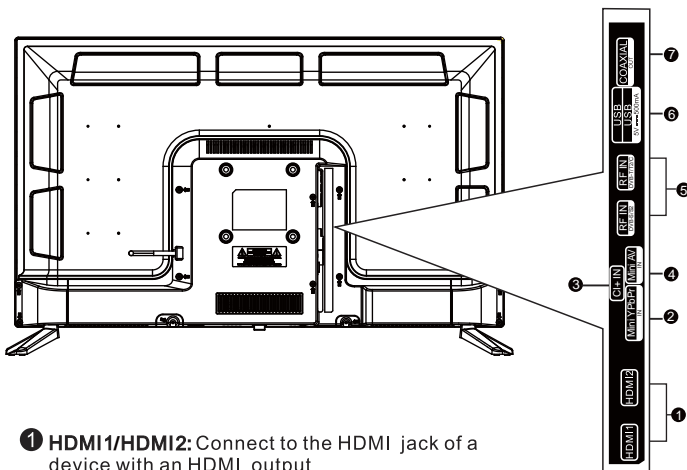

- ① **HDMI1/HDMI2:** Connect to the HDMI jack of a device with an HDMI output.
- ② **YPbPr:** Connect Component video
- ③ **CI:** CI Input.
- ④ **AV IN:** AV Input
- ⑤ **RF:** Connect to an antenna or cable TV system.
- ⑥ **USB:** Connect to USB flash driver to play supported multimedia content.
- ⑦ **COAX:** Connect Coaxial out.

Remote Control

REMOTE CONTROL OUTLOOK & FUNCTION KEY DEFINITION

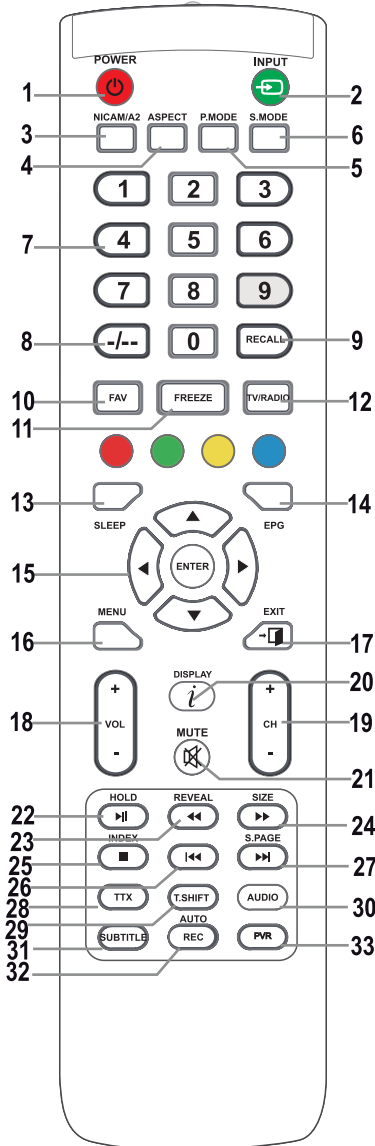

1. POWER button

Turns the television on from the stand-by mode.

2. INPUT button

Press to select the desired input.

3. NICAM button

NICAM/A2 input or output.

4. ASPECT button

Page aspect ratio selection, e.g. 16:9, Zoom, Auto, 4:3

5. P-MODE button

Press to select a picture mode.

6. S-MODE button

Press to select a sound mode.

7. Numerical buttons 0-9

Press 0-9 to directly select a TV channel while watching the TV. In teletext mode enter the page number, etc.

8. --/-- button

It is used to enter channel numbers with various digit counts, e.g. for 1 – 11 – 111.

9. RECALL button

Button for switching to the previously watched channel.

10. FAV button

Press in the TV mode to enter/exit the favourites menu.

11. FREEZE button (freeze)

Freeze the picture

12. TV/RADIO button

Switching between the television and radio modes.

13. SLEEP button

Set the automatic shut off time for the television.

14. EPG button

Press to show/hide the electronic program guide.

15. ////ENTER buttons

Used for navigating in a menu on the screen and for setting up the television according to your preferences.

ENTER button

It is used to enter / exit the Channel list menu. (Only DTV/ATV)

16. MENU button

In TV mode, it displays the LCD television's main menu.

17. EXIT button

Function for exiting a menu or a screen.

18. VOL+/- buttons

Press to increase/decrease the volume.

19. CH +/- buttons

Press to switch between individual channels.

20. DISPLAY button

Button for displaying the source and information about channels.

Remote Control

21. MUTE button

Press to mute the sound. Press it again to renew the sound or press VOL +.

22. HOLD/▶|| button

HOLD button: hold the current display

In the MEDIA mode: Playback/pause or start a time shift recording.

23. REVEAL/◀◀ button

REVEAL button: Press REVEAL to display or hide hidden teletext information (depends on the broadcast).

◀◀ button: fast rewind

24. SIZE/▶▶ button

SIZE button: Press SIZE to change the size of the screen in the MEDIA mode.

▶▶ button: fast forward .

25. INDEX/■ button

INDEX button: call up a teletext content page.

■ button: Stop recording / playback.

26. I◀◀ button

In the MEDIA mode: skip to the previous track

27. S.PAGE/▶▶I button

S.PAGE button: Press S.PAGE to enter a teletext subpage.

▶▶I button: skip to the next track .

28. TTX button

Turn teletext on or off.

Note: The teletext function is optional and the availability of buttons depends on the model.

Teletext information fully depends on the operator of the channel.

29. T.SHIFT button

It is used to start recording with a time shift (i.e. time shift). Function is only available in the DTV mode.

30. AUDIO button

DTV/MEDIA mode: select a background sound, if available.

ATV mode: select a sound mode: Stereo/Dual I/II/Mono.

Other sources: select the left / right channel

31. SUBTITLE button

Button for showing / hiding subtitles in the bottom part of the screen, if they are available.

32. AUTO / REC button

AUTO button: Used for automatic configuration in the PC mode.

REC button: Press to start recording. (only in the DTV mode.)

33. PVR button

It is used to enter / exit the PVR setting menu.

Note:

Remove battery during storage or when you are not using the device for a long time.

To control the device using the remote control, point the remote control at the device and then press the button with the required function. The maximum range of the remote control is about 5 meters with a deviation of up to +/- 30° from the perpendicular direction to the reception sensor of the remote control on the front side of the device. The falling capacity of the batteries gradually reduces the remote control range. There must be no solid obstacles in the area between the remote control and the device when the remote control is being used.

During standard use the lifetime of batteries in the remote control is about 1 year.

When the effective range of the remote control is substantially reduced, or when there are problems with its use, change both the batteries in the remote control.

If you will not be using the remote control for a longer period of time, take out both batteries from it – in this way you will prevent potential damage caused by their leakage.

Avoid strong impact of light (e.g. sunlight or light from strong fluorescent/saving sources) which can reduce the effectiveness and reliability of IR remote control.

Connecting a TV aerial or satellite dish to your TV

To use with a satellite dish (for Freesat or other DVB-S/S2 channels)

Connect your dish to the TV's input marked "RF S2".

To use with an aerial (for Freeview, Saorview etc. or other DVB-T2 channels)

Connect a TV Aerial to the TV's input marked "RF T2".

First Time Installation

When you first turn your TV on you will see the First Time Installation screen, you can also start the first time installation procedure by pressing the menu button and using the ◀ / ▶ buttons to move to the setup menu and then use the ▼ / ▲ buttons to select "First Time Installation" and press OK.

Select Language

Press ◀ / ▶ button to select the language to be used for menus and messages.

Select Country

Press ▼ / ▲ button to highlight country menu.

Press ◀ / ▶ button to select the country you are in.

Press the OK button.

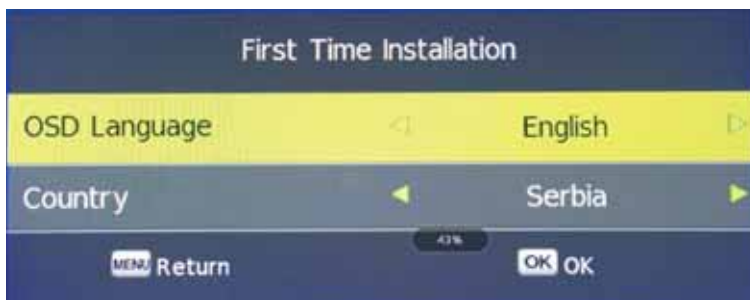

Select Connection Type

Press ▼ / ▲ button to highlight TV Connection menu.

Press ◀ / ▶ button to select the type of connection you are using.

Antenna for use with a TV antenna (Freeview, Saorview etc.)

Satellite for use with a satellite dish (Freesat or other free-to-air satellite TV)

Cable for a cable television service.

Set Tune Type to DTV

Press the OK button.

First Time Setup

To use with a satellite dish (DVB-S2 eg. Freesat.)

Load the preset channel database

On the "Satellite AutoTuning Setting" menu leave the Scan Mode set to Normal Scan and press OK
Press ◀ / ▶ button to select the satellite to use, eg. ASTRA 2E,2F,2G for the UK Freesat service.
Move down to Scan Mode and use the ◀ / ▶ button to select Preset.

Move down to Search and press the OK button.

When you see the message "Do you want to start Satellite Autoscans" press the left arrow button to confirm.

Wait for the Database to be imported, when finished the TV enters viewing mode.

Press OK to view the channel list.

Press the GREEN button to select the satellite list, highlight the satellite you wish to view channels for and press OK

To perform a fresh auto scan or blind scan see page 7



TIP: You can press the AQT (Auto Quick Tune) button on the remote control to jump straight to the Auto Tuning menu if you need to retune.

To use with an aerial (DVB-T2 eg. Freeview, Saorview etc.)

Wait for tuning to finish and then the TV enters viewing mode.

Press OK to view the channel list.



TIP: You can press the AQT (Auto Quick Tune) button on the remote control to jump straight to the Auto Tuning menu if you need to retune.

Menu Operation



Press the **SOURCE** button to display the input source list,

Press **▼ / ▲** or **OK** button to select the input source you want,

Press **OK** button to enter the input source or press the **EXIT** button to quit.

The available inputs are:

DTV: Digital TV with an aerial (DVB-T2 eg. Freeview, Saorview etc.)

Cable: For cable TV services outside the UK

Satellite: For use with a satellite dish (DVB-S2 eg. Freesat.)

ATV: Analogue TV with an aerial.

AV: For connection of a composite video and audio signal to the Mini AV socket.

YPbPr: For connection of a component video signal to the Mini Y/Pb/Pr socket.

HDMI1: For the HDMI 1 socket.

HDMI2: For the HDMI 2 socket.

Media: For playback of media connection to the USB socket on the side of the TV.

Channel Menu

Press **MENU** button to display the main menu.

Press **◀ / ▶** button to select **CHANNEL** in the main menu.

In Antenna Source.



1. Press **▼ / ▲** button to highlight the option that you want to adjust in the **CHANNEL** menu.
2. Press **OK** button to select the highlighted option.
3. After finishing your adjustment, Press Menu button to save and return to the previous menu.

Auto Tuning

Press **▼ / ▲** button to select Auto Tuning, then press **OK** button to enter.

Select the correct country and press **OK**.



TIP: You can press the AQT (Auto Quick Tune) button on the remote control to jump straight to the Auto Tuning menu if you need to retune.

Menu Operation

To skip ATV tuning and move straight on to DTV tuning press the **MENU** button followed by the left arrow.



ATV Manual Tuning



Storage to
Set the channel number.

Sound System
Select the sound system

Colour System
Select the colour system
(Available System: AUTO, PAL, SECAM)

Fine-Tune
Adjust the frequency of the channel finely.

Search
Start searching channel.

Menu Operation

DVB-T Manual Tuning

Press ▼ / ▲ button to select DVB-T Manual Tuning, then press **OK** button to enter sub-menu.
Press ◀ / ▶ button to select channel, then press **OK** button to search program.



Program Edit (reordering the channel list)

Press ▼ / ▲ button to select Program Edit, then press **OK** button to enter sub-menu.



The three colored keys are shortcut keys for programming the channel.

First press ▼ / ▲ to highlight the channel you want to select, then:

Press the **Red** button to delete the program in the list.

Press the **Yellow** button to move the channel in favourite list.

Press the Blue button to skip the selected channel.

Press Fav button to add or remove the channel to your favourite list.

(Your TV set will skip between these channels automatically when using CH+/- to view the channels.)

The CHANNEL List in Satellite Source.



Menu Operation

Auto Tuning

Press ▼ / ▲ button to select Auto Tuning, then press **OK** button to enter.



Press MENU button to bring up the main menu. Highlight "Channel" using navigation buttons and press OK. Then highlight "Auto Tuning" and press OK to enter.

Satellite: Select an available satellite.
Channel Type: Select a channel type.
Service Type: Select a service type.
Scan Mode: Select your scan mode.
Unicable: Select Off

Select Search and press OK.



TIP: You can press the AQT (Auto Quick Tune) button on the remote control to jump straight to the Auto Tuning menu if you need to retune.

Satellite Edit

Press ▼ / ▲ button to select **Satellite Edit** then press **OK** button to enter.



Highlight the satellite to edit and press OK. Select the field to change and the ◀ / ▶ buttons to change the settings.



Picture Menu

Press **MENU** button to display the main menu.

Press ◀ / ▶ button to select **PICTURE** in the main menu.



1. Press ▼ / ▲ button to select the option that you want to adjust in the **PICTURE** menu.
2. Press **OK** button to adjust.
3. After finishing your adjustment, Press **MENU** button to save and return back to the previous menu.

Picture Mode

Press ▼ / ▲ button to select Picture Mode, then press **OK** button to enter sub-menu.

Press ◀ / ▶ to cycle through the modes Standard, Dynamic, Mild and User.

Note: You can change the value of contrast, brightness, saturation, tint and sharpness manually when set to **Standard** mode.

Contrast/ Brightness/ Saturation/ Sharpness/Tint

Press ▼ / ▲ button to select option, then press ◀ / ▶ button to adjust.

Contrast Adjust the highlight intensity of the picture, but the shadow of the picture is invariable.

Brightness Adjust the optical fiber output of the entire picture, it will effect the dark region of the picture.

Saturation Adjust the saturation of the colour based on your own like.

Sharpness Adjust the peaking in the detail of the picture.

Tint (NTSC only) Use in compensating color changed with the transmission in the NTSC code.

TIP: In viewing mode you can press PMODE button to cycle through the picture modes quickly.

Menu Operation

Color Temp

Change the overall color cast of the picture.

Press ▼ / ▲ button to select Colour Temperature, then ◀ / ▶ to cycle through the options:

- Normal** No adjustment
- Cold** Increase the blue tone for the white.
- Warm** Increase the red color for the white.

Aspect Ratio

Manually change the aspect ration of the picture

Press ▼ / ▲ button to select Aspect Ratio, then ◀ / ▶ to cycle through the options:

16:9 (default), Zoom1, Zoom2, Auto, 4:3

Noise Reduction

To filter out and reduce image noise and improve picture quality.

Press ▼ / ▲ button to select Noise Reduction, then ◀ / ▶ to cycle through the options:

- Off** Select to turn off video noise detection.
- Low** Detect and reduce low video noise.
- Middle** Detect and reduce moderate video noise (default)
- High** Detect and reduce enhanced video noise.

Sound Menu

Press **MENU** button to display the main menu.
Press ◀ / ▶ button to select **SOUND** in the main menu.



1. Press ▼ / ▲ button to select the option that you want to adjust in the **SOUND** menu.
2. Press **OK** button to adjust.
3. After finishing your adjustment, Press **Enter** button to save and return to the previous menu.

Sound Mode

Press ▼ / ▲ button to select Sound Mode, then ◀ / ▶ to cycle through the options:

Standard	Produces a balanced sound in all environments.
Music	Preserves the original sound. Good for musical programs.
Movie	Enhances treble and bass for a rich sound experience.
Sports	Enhances vocals for sports.
User	Select to customise sound settings.

Balance

Press ▼ / ▲ button to select option, Press ◀ / ▶ button to adjust.

Auto Volume level

This reduces the difference between channel and programme volumes automatically
Press ▼ / ▲ button to select Auto Volume Level, then press ◀ / ▶ button to select On or Off.

SPDIF Mode

Press ▼ / ▲ button to select SPDIF Mode, then press ◀ / ▶ button to select Off / PCM / Auto.

AD Switch (Audio Description)

Press ▼ / ▲ button to select AD Switch, then press ◀ / ▶ button to select On or Off.

AD Volume (Audio Description Volume)

When AD Switch is On Press ▼ / ▲ button to select AD Volume, then press ◀ / ▶ button to adjust volume of audio description.

Time Menu

Press **MENU** button to display the main menu.

Press **◀ / ▶** button to select **TIME** in the main menu.



Clock

Press **▼ / ▲** button to select Clock and then press **OK** to open the submenu.

Press **▼ / ▲** button to select each entry, then **◀ / ▶** to adjust the date, month, year, hour and minute.

Off Time

The TV will automatically enter standby mode at the this time.

Press **▼ / ▲** button to select Off Time and then press **OK** to open the submenu.

Press **▼ / ▲** button to select Off Time and then **◀ / ▶** to cycle through the options:
Once, Every Day, Mon.~Fri., Mon.~Sat., Sat.~Sun., Sunday.

Press **▼ / ▲** button to select Hour, then **◀ / ▶** to adjust the hours.

Press **▼ / ▲** button to select Minute, then **◀ / ▶** to adjust the minutes.

On Time

The TV will automatically turn on from standby mode at the this time.

Press **▼ / ▲** button to select Off Time and then press **OK** to open the submenu.

Press **▼ / ▲** button to select Off Time and then **◀ / ▶** to cycle through the options:
Once, Every Day, Mon.~Fri., Mon.~Sat., Sat.~Sun., Sunday.

Press **▼ / ▲** button to select Hour, then **◀ / ▶** to adjust the hours.

Press **▼ / ▲** button to select Minute, then **◀ / ▶** to adjust the minutes.

Press **▼ / ▲** button to select the source, then **◀ / ▶** to choose the source to turn on.

Press **▼ / ▲** button to select Channel, then **◀ / ▶** to select the channel to tune to.

Press **▼ / ▲** button to select Volume, then **◀ / ▶** to set the volume used when the TV is turned on.

Menu Operation

Sleep Timer

Press ▼ / ▲ button to select Sleep Timer, then ◀ / ▶ to cycle through the options:

Off, 10min, 20min, 30min, 60min, 90min, 120min, 180min, 240min.

The TV will turn off after the set time has passed.

Auto Standby

Press ▼ / ▲ button to select Auto Standby, then ◀ / ▶ to cycle through the options:

Off, 3 H, 4 H, 5 H.

The TV will automatically turn off after the preset time if no remote control buttons are pressed. Pressing a button will reset the timer.

Time Zone

Press ▼ / ▲ / ◀ / ▶ button to select time zone and then **Menu** to return to the Time menu.

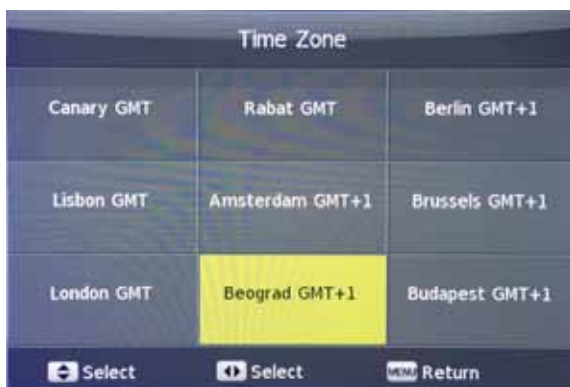

OSD Timer

Press ▼ / ▲ button to select OSD Timer, then ◀ / ▶ to cycle through the options:

5, 10, 15, 20, 25, 30, Always.

This controls how long the OSD (On Screen Displays) menus will stay on screen after a button is pressed. If set to Always the OSD will remain on screen until you press the Exit button.

Option Menu

Press **MENU** button to display the main menu.
Press ◀ / ▶ button to select **SETUP** in the main menu.



OSD Language

Select a language for the OSD (On Screen Display) menus. The default language is English.

Press ▼ / ▲ button to select OSD Language and then **OK** to open the submenu.

Press ▼ / ▲ / ◀ / ▶ button to select the language and then **Menu** to return to the Option menu.



TT Language

Press ▼ / ▲ button to select TT Language, then ◀ / ▶ to cycle through the options: West, East, Russian, Arabic, Persian.

Menu Operation

Audio Language

Press ▼ / ▲ button to select Audio Language, then press **OK** button to enter the sub-menu.

Press ▼ / ▲ / ◀ / ▶ buttons to select the Audio Language.

Press **Menu** to return to the Option menu.



Subtitle Language

Press ▼ / ▲ button to select Subtitle Language, then press **OK** button to enter the sub-menu.

Press ▼ / ▲ / ◀ / ▶ buttons to select the Subtitle Language.

Press **Menu** to return to the Option menu.



Hearing Impaired

Press ▼ / ▲ button to select Hearing Impaired, then press ◀ / ▶ to select On or Off.

PVR File System

Settings for the Personal Video Recorder (PVR) function. A USB device (USB stick/thumb drive or hard drive must be connected to the TV, maximum size 1TB formatted in FAT32 or NTFS).

Press ▼ / ▲ button to select PVR File System, then press **OK** button to enter sub-menu.

If you have more than one USB device connected press **OK** to select the disk.

Press ▼ / ▲ button to select Check PVR File System, then press **OK** button to enter.

This will check the USB format, speed and size.



Menu Operation

Format

Press \blacktriangledown / \blacktriangle button to select Format, then press **OK** button to enter sub-menu.

This will show you the maximum recording time for SD and HD recordings and allow you to format (wipe clean) the device.

CAUTION: Formatting the device will permanently delete **ALL** files from the device not just TV recordings.

Time Shift Size

The Time Shift Size sets how much disk space will be allowed to be used for time shift recordings, ie. how long you can pause or rewind a live recording for.

Press \blacktriangledown / \blacktriangle button to select Time Shift Size, then press **OK** button to enter sub-menu.

Press the \blacktriangleleft / \blacktriangleright buttons to adjust the size between:

0 GB Time shift is disabled

512 MB SD recording time of 14 mins, HD recording time of 4 Mins

1 GB SD recording time of 28 mins, HD recording time of 8 Mins

Free Record Limit

Press \blacktriangledown / \blacktriangle button to select Free Record Limit, then press the \blacktriangleleft / \blacktriangleright buttons to adjust the time for manual recording between 1 and 6 hours.

Reset

This will reset the TV to the factory defaults.

Press \blacktriangledown / \blacktriangle button to select Reset, then press **OK** button to enter sub-menu.

Press \blacktriangleleft to confirm you want to reset or \blacktriangleright to cancel.

HDMI CEC

Press \blacktriangledown / \blacktriangle button to select HDMI CEC, then press **OK** button to enter the sub-menu.



HDMI CEC

Press \blacktriangleleft / \blacktriangleright button to turn the CEC Control on or off.

HDMI ARC

Press \blacktriangleleft / \blacktriangleright button to turn the Audio Receiver Control on or off.

Auto Standby

Press \blacktriangleleft / \blacktriangleright button to turn the Device Auto Standby on or off.

Auto TV On

Press \blacktriangleleft / \blacktriangleright button to turn the Auto TV Power On on or off.

Device control

Press \blacktriangleleft / \blacktriangleright button to turn the Device control on or off.

Device List

Press **OK** button to show list of device.

First Time Installation

This allows you to restart the first time installation process.

Press \blacktriangledown / \blacktriangle button to select First time installation, then press **OK** button to start.

Blue Screen

When turned on the screen will be blue if there is no signal, if turned off the screen will be black.

Press \blacktriangledown / \blacktriangle button to select Blue Screen then press the \blacktriangleleft / \blacktriangleright buttons to select On or Off.

Lock Menu

Press **MENU** button to display the main menu.
Press ◀ / ▶ button to select **Lock** in the main menu.



1. Press ▼ / ▲ button to select the option that you want to adjust in the **LOCK SYSTEM** menu.
2. Press **OK**/◀ / ▶ button to adjust.
3. After finishing your adjustment, Press **MENU** button to return back to the previous menu

Lock System



Press ▼ / ▲ button to select Lock System,
then press **OK** button to make the remaining options valid.

The default password is 0000.

Set Password



Press ▼ / ▲ button to select Set Password,
then press **OK** button to enter sub-menu to set new password.

Channel Lock

Press ▼ / ▲ button to select Channel Lock then press **OK** button to enter sub-menu to select.
Press **Green** button to lock or unlock the channel.

Parental Guidance

Press ▼ / ▲ button to select Parental Guidance, then press the ◀ / ▶ buttons to select the a that is suitable for your children.

Key Lock

Press ▼ / ▲ button to select Key Lock, then press ◀ / ▶ button to select Off or On.
When Key Lock is turned on the buttons on the rear of the TV are disabled.

Hotel Menu



1. Press **▼ / ▲** button on the remote control to select hotel mode in the **Lock** menu.
2. Press **OK** button on the remote control to enter the sub-menu.
3. After finishing your adjustment, Press **MENU** button to save and return back to the previous menu.

Hotel Mode

Press **▼ / ▲** button to select Hotel Mode, then press **◀ / ▶** button to select on or off.

Source Lock

Press **▼ / ▲** button to select Source Lock, then press **OK** button to enter sub-menu to select.

Default Source

Press **▼ / ▲** button to select Default Source, then press **OK** button to enter sub-menu to select.

Default Prog

Press **▼ / ▲** button to select Default Prog, then press **◀ / ▶** button to adjust.
It is available when the default source is TV.

Max Volume

Press **▼ / ▲** button to select Max Volume, then press **◀ / ▶** button to adjust.

Default Volume

Press **▼ / ▲** button to select Default Volume, then press **◀ / ▶** button to adjust.

Clear Lock

Press **▼ / ▲** button to select Clear Lock, then press **OK** button to reset the lock settings to default.

Menu Operation

EPG

Press EPG button on remote control to enter EPG menu page.

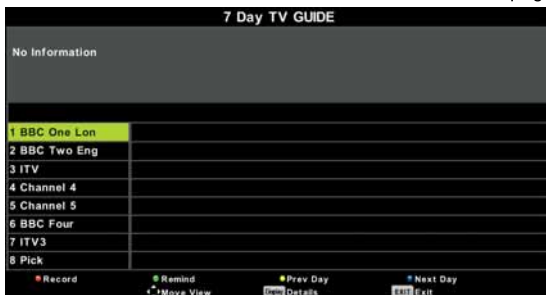

Press ∇ / \blacktriangle navigation buttons to select preferred program.

Press \blacktriangleleft / \blacktriangleright navigation buttons to switch between left column and right column.

When a program is highlighted

Press RED button to record program.

Press GREEN button display information on the highlighted program.

Press YELLOW button to recording schedule.

Press BLUE button to set a reminder.

FAVOURITE LIST

When viewing a channel, press the FAV button on the remote control to enter the Favorite List menu.

Press ∇ / \blacktriangle navigation buttons to select your preferred channel.

Press OK button to confirm the selection.

NOTE:

To add a favourite channel, please refer to the operations of "DTV Mode > Channel > Programme Edit"



Quick select

When viewing an available channel, press OK button on remote control to enter Channel List menu page.

Press UP or DOWN navigation buttons to select preferred channel.

Press LEFT/RIGHT navigation buttons to select a channel group.

Press OK button to confirm the selection.



Media Menu

USB

Note: Before operating **Media** menu, Plug in USB device, then press SOURCE button to set the Input Source to **Media** . Press **▼ / ▲** button to select **Media** in the Source menu, then press **OK** button to enter.



Press **◀ / ▶** button to select the option you want to adjust in the main **Media** menu, then press **OK** button to enter.

Media Menu

Photo Menu

Press ◀ / ▶ button to select PHOTO in the main menu, then press **OK** button to enter.
Press **Exit** button to return to the previous menu and exit menu to quit.

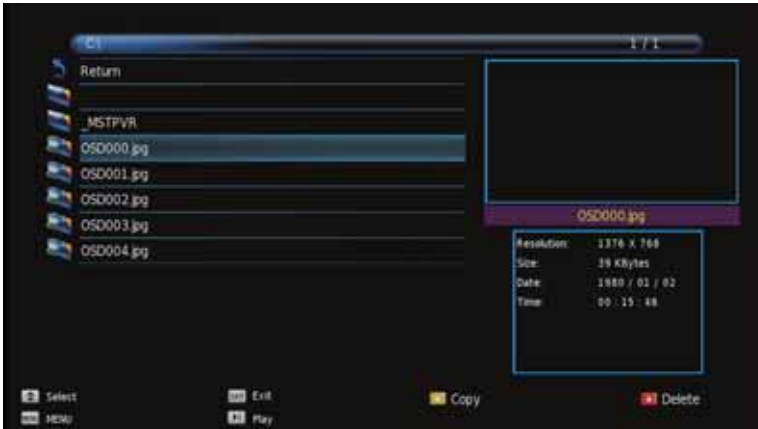

Press ◀ / ▶ button to select the file you want to watch in the file selecting menu, then press media button to display picture.

When highlighting the option you select, the file information will appear on the right and picture will be previewed in the center.

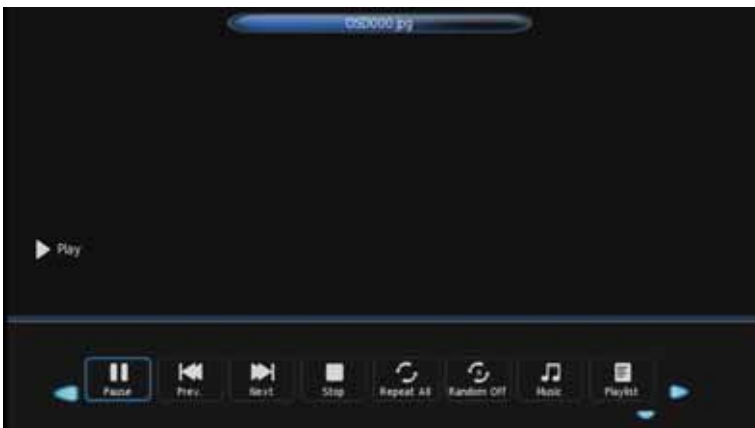

Media Menu

Music Menu

Press ◀ / ▶ button to select MUSIC in the main menu, then press **OK** button to enter.

Press **Exit** button to return to the previous menu and exit menu to quit.



Press ◀ / ▶ button to select drive disk you want to watch, then press **OK** button to enter.

Press ◀ / ▶ button to select return option to the previous menu.



Media Menu

Movie Menu

Press ◀ / ▶ button to select MOVIE in the main menu, then press **OK** button to enter.
Press **Exit** button to return to the previous menu and exit menu to quit.



Press ◀ / ▶ button to select drive disk you want to watch, then press **OK** button to enter.
Press media button to play the selected movie.
Press display button to select menu in the bottom you want to run, then press **OK** button to operate.
Press **Exit** button to back to the previous menu and exit button to quit the entire menu.



Media Menu

Text Menu

Press ◀ / ▶ button to select TEXT in the main menu, then press **Enter** button to enter.

Press **Exit** button to return to the previous menu and exit menu to quit.



Press ◀ / ▶ button to select drive disk you want to watch, then press **Enter** button to enter.

Press ◀ / ▶ button to select return option to back to the previous menu.

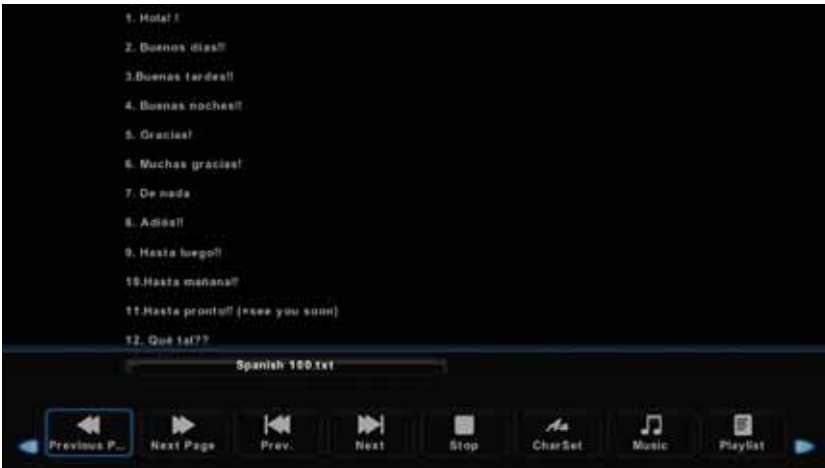

External connection

1. Assemble the stand

Before attaching/detaching the stand, make sure to turn off the TV.

-Before performing work spread cushioning over the base area to lay the LED TV on. This will prevent it from being damaged.

Stand installation instruction

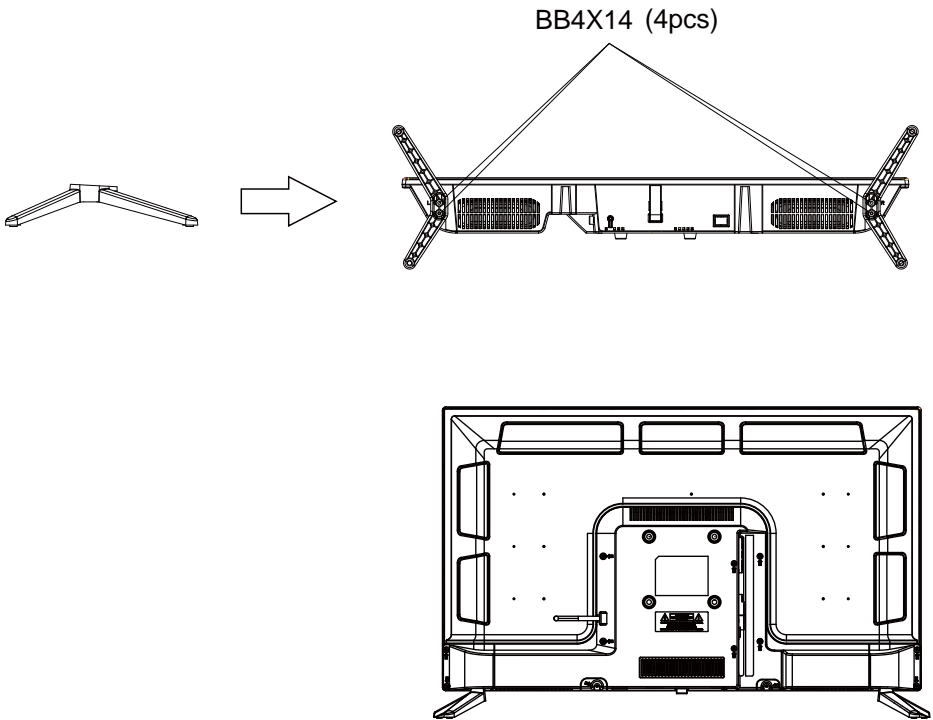

Reference

Troubleshooting

If you have any problem, check the counter measures for each symptom listed below. The following symptoms may have been caused by inappropriate adjustment rather than actual malfunction of the unit. If the trouble persists, contact the Customer Care Centre, see back page for contact details.

Symptoms	Possible solutions
No power	Please check the power cord plugged in and that the power outlet works. Unplug the power cord and plug it in after 60 seconds and restart the TV.
No picture	Please check antenna connection. Station may be experiencing problems, please tune to another station. Please adjust the settings of contrast and brightness.
Good picture but no sound	Please increase the volume. Please check TV is under mute mode, press MUTE button on the remote control. Please check sound settings If external devices are being used, check their volumes are not set too low or turned off. If using AVI or Component inputs, please make sure cables are connected properly and not loose. If using DVI to HDMI cable, a separate audio cable is required. Make sure a headphone jack is not connected..
Good sound but abnormal color or no picture	Please check antenna connection and antenna condition. If using Component input, please check Component connections, incorrect or loose connections may cause colour problems or cause the screen to be blank.
No response to remote control	Batteries of remote control may have exhausted, if necessary, please change the batteries. Clean the remote control lens. The distance between LED TV and remote control should be within 8m, within recommended operating angle and path is free of obstructions.
Full screen flickering under VGA	V-HEIGHT value may be set too big, restart computer and enter safe mode, then set monitor parameters to correct value according to adjustment description.
Horizontal stripes under VGA	Sample phase may be deflected, adjust phase according to picture position.
Colored dots may be present on the screen	Although the LED screen is made with high-precision technology and 99.99% or more of the the pixels are effective, black dots may appear or bright points of light (red, blue, or green) may appear constantly on the LED screen. This is a structural property of the LED screen and not a malfunction.
Picture is breaking up	Keep the TV away from noisy electrical sources such as cars, hair dryers, welders, and all optional equipment. Electrical atmospheric interference such as local or distant lightning storms may cause picture to break up. When installing optional equipment, leave some space between the optional equipment and the TV. Check the antenna and connection. Keep the antenna away from any power or input/output cables.

Reference

Troubleshooting

After Auto Tuning only some channels are available	Check your area is covered by Digital Video Broadcasts. Try re-tuning or manually tuning missing channels. Check that you are using the correct antenna type - please see pg.16 'Antenna connection'.
Channel cannot be selected	Check if the channel has been blocked in the main menu settings.
USB not playing	Please check connecting USB cable and power supply is connected. Hard drive has not been formatted. Please make sure USB disk is compatible and the multimedia data formats are supported.
Picture is distorted, macroblock, small block, dots, pixelization, etc	Compression of video contents may cause distortion especially on fast moving pictures such as sports and action movies.
Noise from speaker	Check cable connections, make sure a video cable is not connected to an audio input. Low signal level may cause sound distortion.
TV turns off automatically	Check if the Off Timer or Sleep timer is turned on.
TV turns on automatically	Check if the On Timer is set to On in the Setup menu.
Picture is not shown in full screen	First check if it is caused by the input signal. Then try to adjust Zoom in Function menu.

Picture defects and the reason



Snowy Picture

Snowy picture is usually due to weak signal. Adjust antenna or install an antenna amplifier.



Double Image or Ghosts

Double images are usually caused by reflections from tall buildings. Adjust the direction of the antenna or raise it.

Ghosting may also occur when still pictures are displayed continuously. It may disappear after a few moments.



Radio Wave Interference

Wave patterns are moving on the screen, which are usually caused by nearby radio transmitters or short-wave receiving equipment.



High Temperature Electrothermal Interference

Diagonal or herringbone patterns appear on the screen or part of picture is missing. This is probably caused by high temperature electrothermal equipment in a nearby hospital.

